

## Product Information: CorTen-steel planters

Material thickness of Corten-Steel planters is standard 2mm. Production in 3-4 and 5mm is possible.

Corten steel is a metal alloy made of iron which has copper, silicon, nickel and chromium added. When exposed to the weather, it develops a protective layer of rust giving these planters a warm and natural look. The rust layer seals the steel underneath, protecting against further corrosion, making it an extremely long lasting durable product.

Characteristic of Cor-Ten steel is rust orange brown color and longevity.

### Advantages:

- Strong / durable.
- Designed to weather.
- Warm, natural look.
- Customization possible.

### Optional:

- legs 100x100x90mm height (only for model ANDES).
- Interior Application possible (Optional Interior waterproofing).
- Assembly recessed wheels possible (only in Model ANDES).
- We can provide 'Owatro' varnish which will stop the item from rusting any further.



The top edge of the planters is folded twice, which creates a sturdy planter with a timeless appearance.

As standard they come with 15mm feet and drainage holes. It is important that the planter has good drainage and there should be no excess water in the planter. Hydro Grit is not recommended because this product holds water.

Models: Andes, Atlas, Celso and Cado



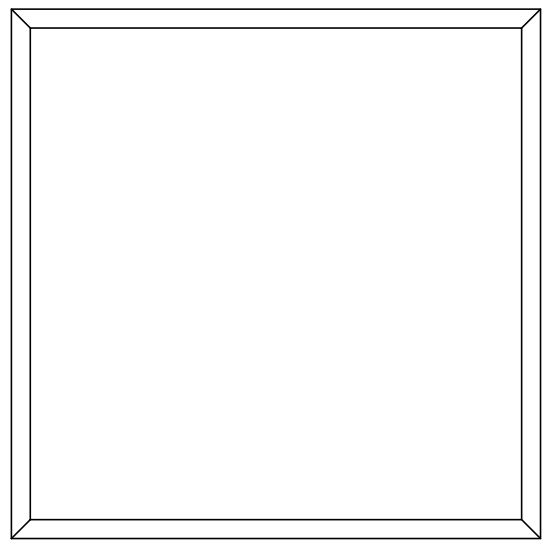

50  
1300  
1400  
50

50 1300 50  
1400

Bovenaanzicht

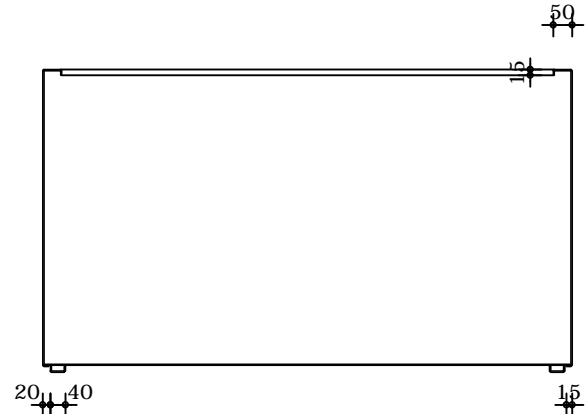

Verticale doorsnede

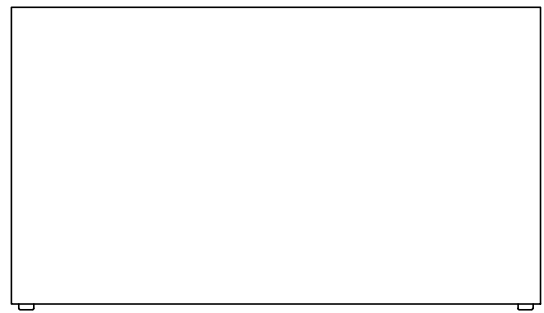

785  
800  
15

Vooraanzicht

Inhoud : 1.57m3  
Gewicht : 112kg  
Afwerking : Nvt

Omschrijving : Andes CA1	Get. : R. Langens
Opdrachtgever : Adezz	Schaal : 1:20
Werknummer : Standaard	Datum : 01-04-2014
Plaats : Uden (NL)	Wijz. :
1/1	

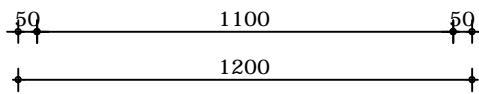
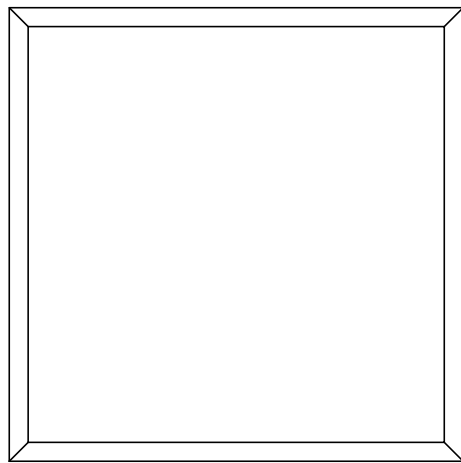

Bovenaanzicht

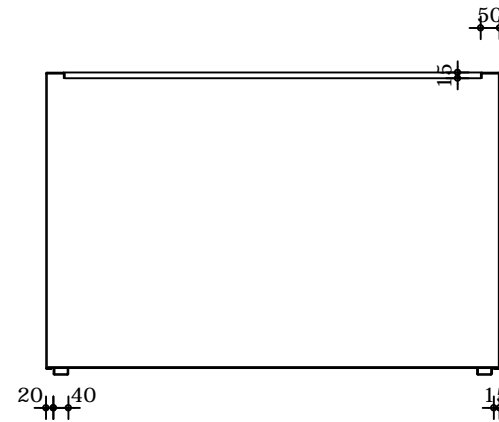

Verticale doorsnede

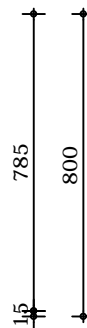
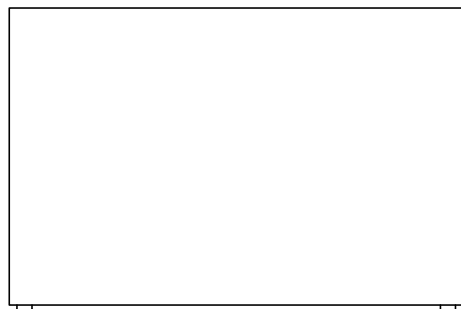

Vooraanzicht

Gewicht : 93kg  
Afwerking : Nvt

Omschrijving : Andes CA2  
Opdrachtgever : Adezz  
Werknummer : Standaard  
Plaats : Uden (NL)  
1/1

Get. : R. Langens  
Schaal : 1:20  
Datum : 01-04-2014  
Wijz. :

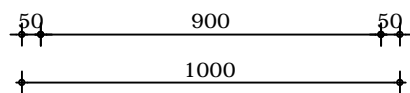
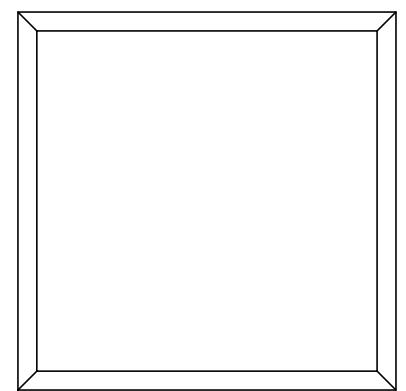

Bovenaanzicht

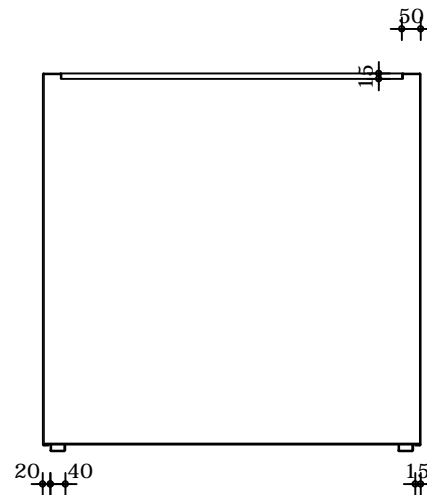

Verticale doorsnede

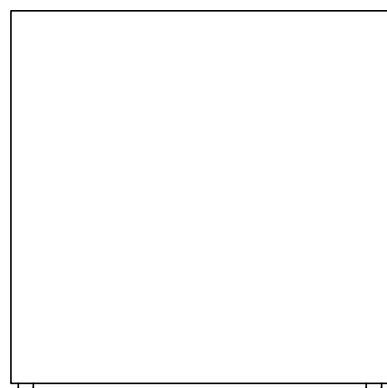

Vooraanzicht

Gewicht : 89kg  
Afwerking : Nvt

Omschrijving : Andes CA3  
Opdrachtgever : Adezz  
Werknummer : Standaard  
Plaats : Uden (NL)  
1/1

Get. : R. Langens  
Schaal : 1:20  
Datum : 01-04-2014  
Wijz. :

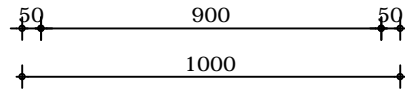
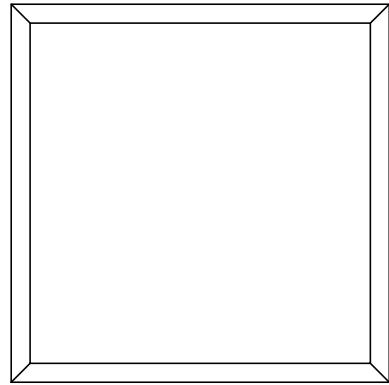

Bovenaanzicht

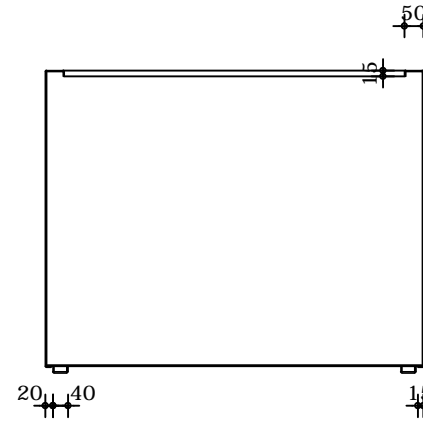

Verticale doorsnede

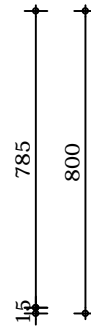
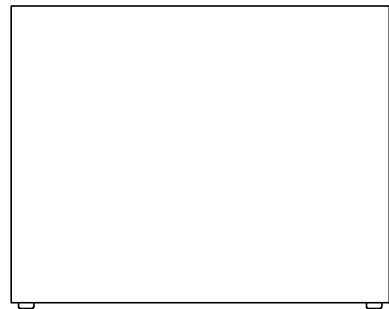

Vooraanzicht

Gewicht : 75kg  
Afwerking : Nvt

Omschrijving : Andes CA4  
Opdrachtgever : Adezz  
Werknummer : Standaard  
Plaats : Uden (NL)  
1/1

Get. : R. Langens  
Schaal : 1:20  
Datum : 01-04-2014  
Wijz. :

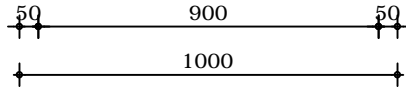
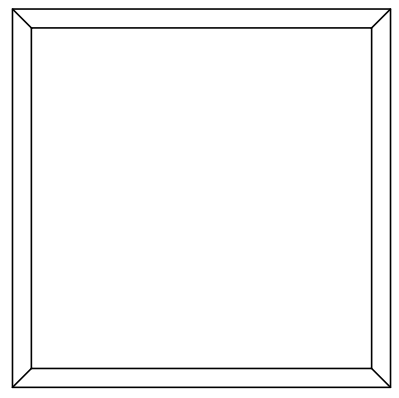

Bovenaanzicht

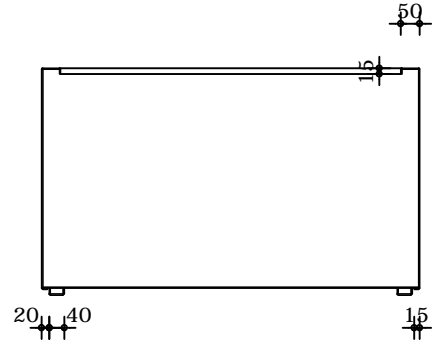

Verticale doorsnede

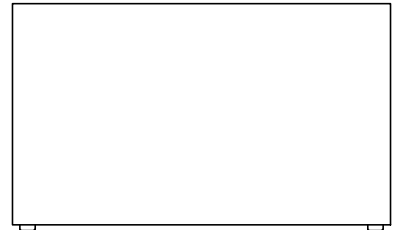

Vooraanzicht

Gewicht : 60kg  
Afwerking : Nvt

Omschrijving : Andes CA4.1	Get. : R. Langens
Opdrachtgever : Adezz	Schaal : 1:20
Werknummer : Standaard	Datum : 01-04-2014
Plaats : Uden (NL)	Wijz. :
1/1	

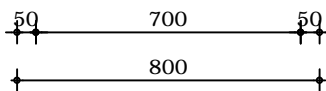
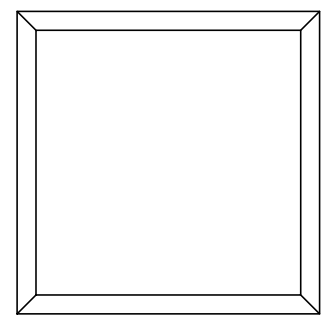

Bovenaanzicht

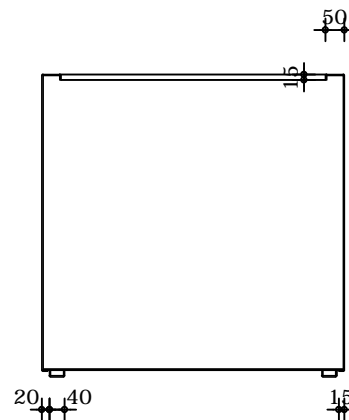

Verticale doorsnede

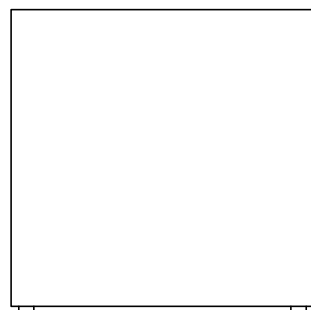

Vooraanzicht

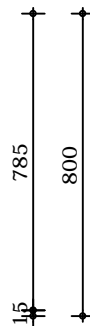

Gewicht : 54kg  
Afwerking : Nvt

Omschrijving : Andes CA5  
Opdrachtgever : Adezz  
Werknummer : Standaard  
Plaats : Uden (NL)  
1/1

Get. : R. Langens  
Schaal : 1:20  
Datum : 01-04-2014  
Wijz. :

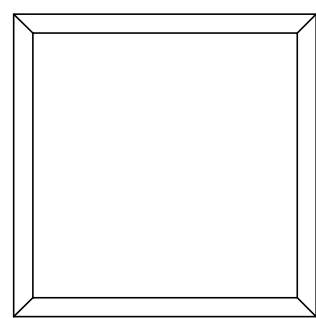

50  
700  
800  
50

50 700 50  
800

Bovenaanzicht

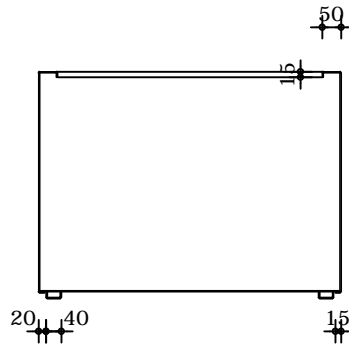

Verticale doorsnede

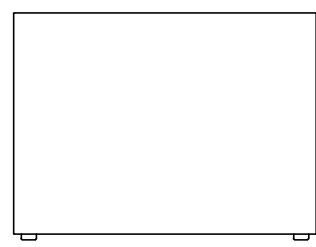

585  
600  
15

Vooraanzicht

Gewicht : 44kg  
Afwerking : Nvt

Omschrijving : Andes CA5.1	Get. : R. Langens
Opdrachtgever : Adezz	Schaal : 1:20
Werknummer : Standaard	Datum : 01-04-2014
Plaats : Uden (NL)	Wijz. :
1/1	



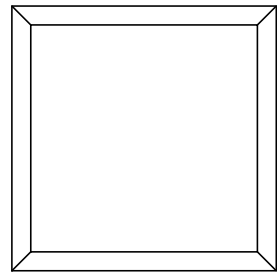

50  
600  
50  
700

50 600 50  
700

Bovenaanzicht

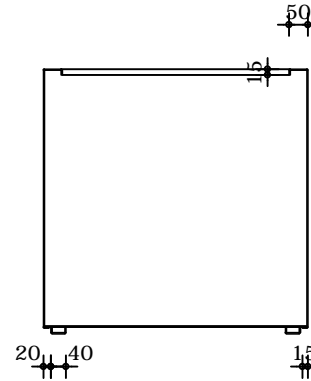

Verticale doorsnede

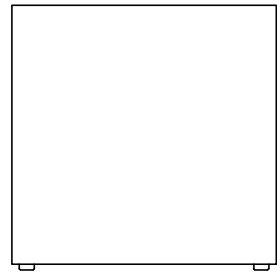

685  
700  
15

Vooraanzicht

Gewicht : 42kg  
Afwerking : Nvt

Omschrijving : Andes CA6  
Opdrachtgever : Adezz  
Werknummer : Standaard  
Plaats : Uden (NL)  
1/1

Get. : R. Langens  
Schaal : 1:20  
Datum : 01-04-2014  
Wijz. :

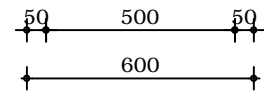
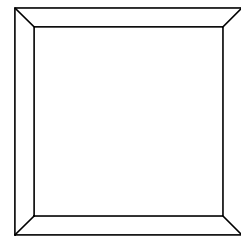

Bovenaanzicht

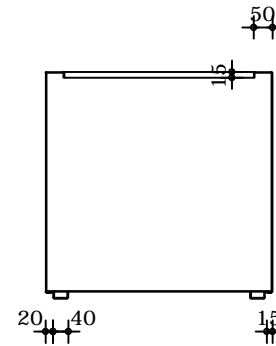

Verticale doorsnede

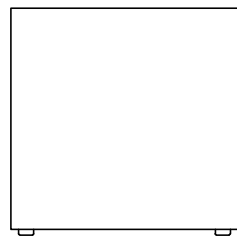

Vooraanzicht



Gewicht :31 kg  
Afwerking : Nvt

Omschrijving : Andes CA7  
Opdrachtgever : Adezz  
Werknummer : Standaard  
Plaats : Uden (NL)  
1/1

Get. : R. Langens  
Schaal : 1:20  
Datum : 01-04-2014  
Wijz. :

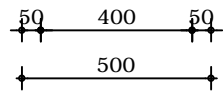
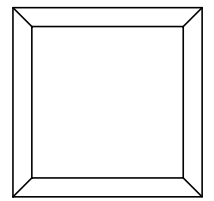

Bovenaanzicht

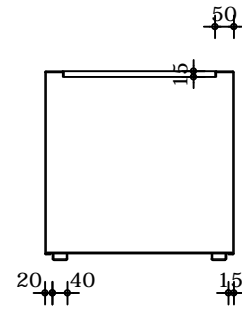

Verticale doorsnede

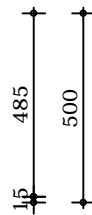
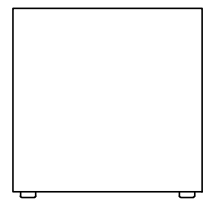

Vooraanzicht

Gewicht : 22kg  
Afwerking : Nvt

Omschrijving : Andes CA8	Get. : R. Langens
Opdrachtgever : Adezz	Schaal : 1:20
Werknummer : Standaard	Datum : 01-04-2014
Plaats : Uden (NL)	Wijz. :
1/1	

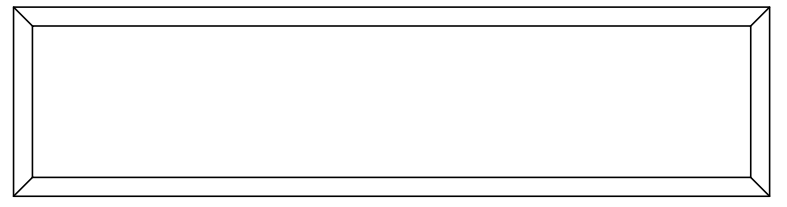

50 1900 50  
2000

Bovenaanzicht

50 400 50  
500

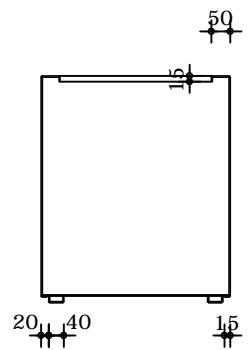

Verticale doorsnede

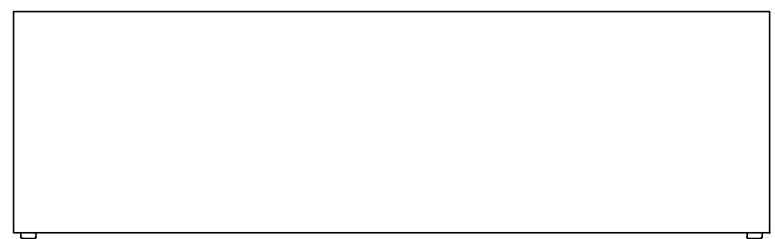

585 600  
15

Vooraanzicht

Gewicht : 69kg  
Afwerking : Nvt

Omschrijving : Andes CA9 Opdrachtgever : Adezz Werknummer : Standaard Plaats : Uden (NL) 1/1	Get. : R. Langens Schaal : 1:20 Datum : 01-04-2014 Wijz. :
--	---

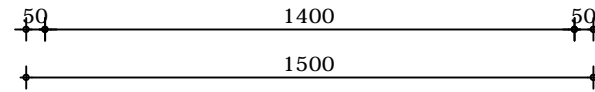
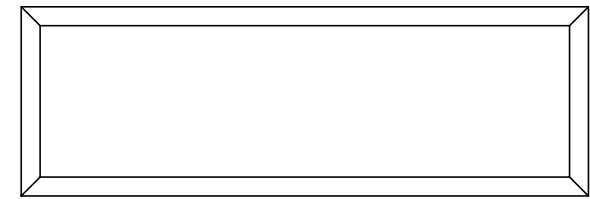

Bovenaanzicht

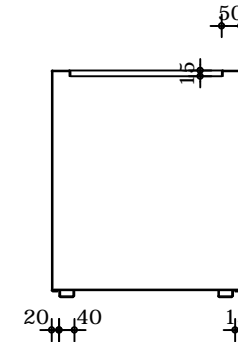

Verticale doorsnede



Vooraanzicht



Gewicht : 54kg  
Afwerking : Nvt

Omschrijving : Andes CA10  
Opdrachtgever : Adezz  
Werknummer : Standaard  
Plaats : Uden (NL)  
1/1

Get. : R. Langens  
Schaal : 1:20  
Datum : 01-04-2014  
Wijz. :

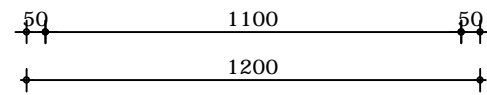
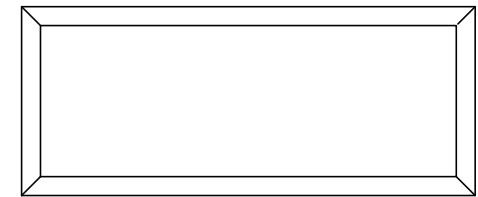

Bovenaanzicht

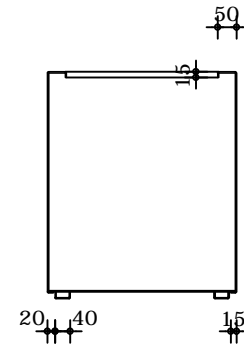

Verticale doorsnede

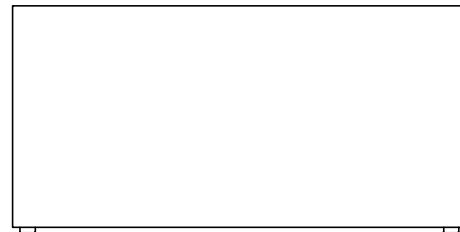

Vooraanzicht

Gewicht : 45kg  
Afwerking : Nvt

Omschrijving : Andes CA11  
Opdrachtgever : Adezz  
Werknummer : Standaard  
Plaats : Uden (NL)  
1/1

Get. : R. Langens  
Schaal : 1:20  
Datum : 01-04-2014  
Wijz. :

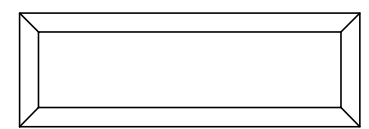

50 200 50  
50 300

50 800 50  
900

Bovenaanzicht

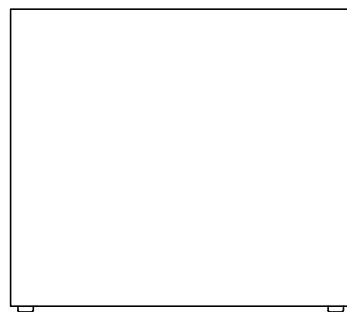

785 800  
15 15

Vooraanzicht

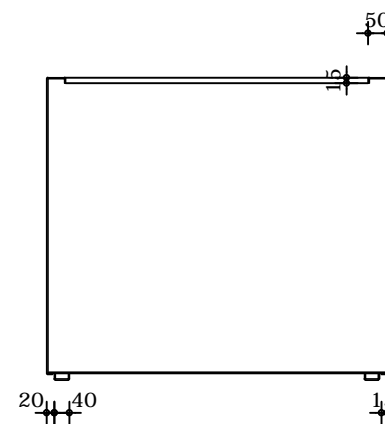

50 15  
20 40 15

Verticale doorsnede

Gewicht : 37kg  
Afwerking : Nvt

Omschrijving : Andes CA12  
Opdrachtgever : Adezz  
Werknummer : Standaard  
Plaats : Uden (NL)  
1/1

Get. : R. Langens  
Schaal : 1:20  
Datum : 01-04-2014  
Wijz. :

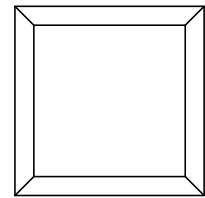

50  
400  
500  
50

50 400 50  
500

Bovenaanzicht

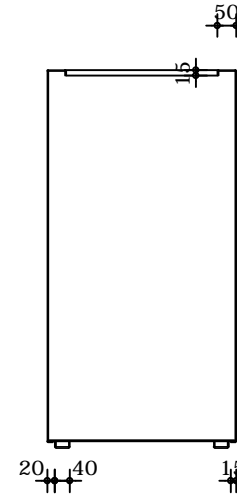

20 40 15 50

Verticale doorsnede



985  
1000  
15

Vooraanzicht

Gewicht : 38kg  
Afwerking : Nvt

Omschrijving : Andes CA13  
Opdrachtgever : Adezz  
Werknummer : Standaard  
Plaats : Uden (NL)  
1/1

Get. : R. Langens  
Schaal : 1:20  
Datum : 01-04-2014  
Wijz. :



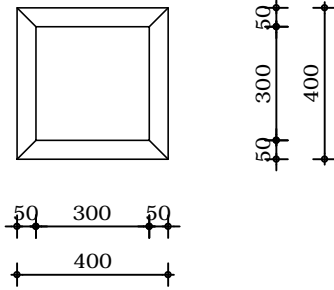

Bovenaanzicht

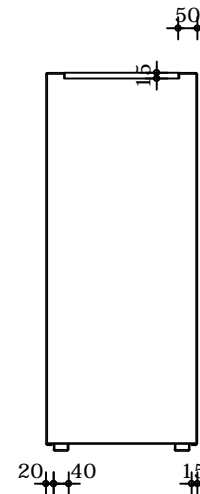
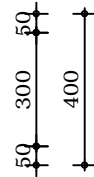

Verticale doorsnede



Vooraanzicht

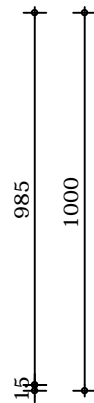

Gewicht : 30kg  
Afwerking : Nvt

Omschrijving : Andes CA14  
Opdrachtgever : Adezz  
Werknummer : Standaard  
Plaats : Uden (NL)  
1/1

Get. : R. Langens  
Schaal : 1:20  
Datum : 01-04-2014  
Wijz. :

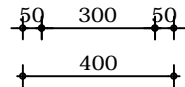
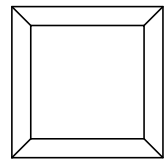

Bovenaanzicht

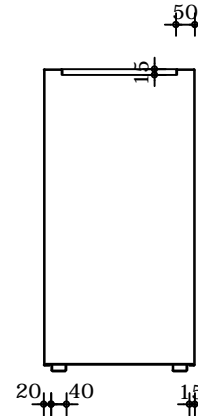
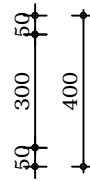

Verticale doorsnede

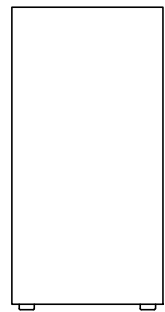

Vooraanzicht

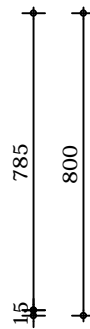

Gewicht : 25kg  
Afwerking : Nvt

Omschrijving : Andes CA15	Get. : R. Langens
Opdrachtgever : Adezz	Schaal : 1:20
Werknummer : Standaard	Datum : 01-04-2014
Plaats : Uden (NL)	Wijz. :
1/1	

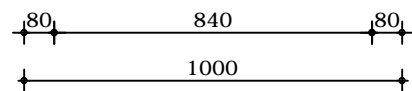
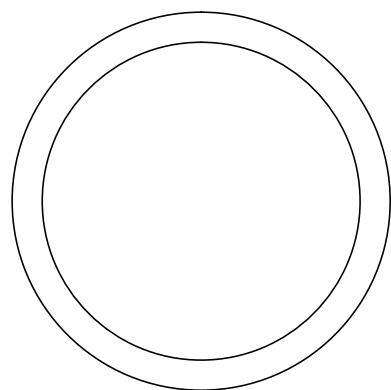

Bovenaanzicht

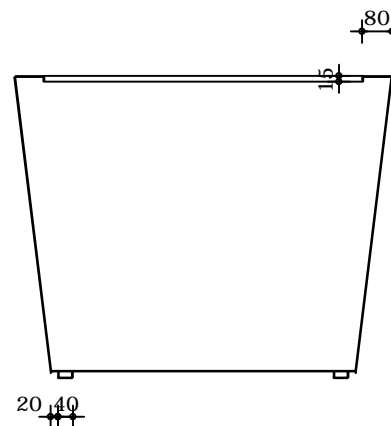

Verticale doorsnede

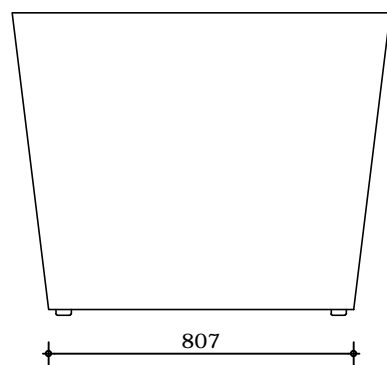

Vooraanzicht

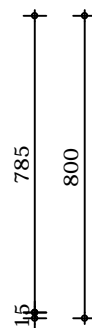

Gewicht : 62kg  
Afwerking : Nvt

Omschrijving : Cado CC1  
Opdrachtgever : Adezz  
Werknummer : Standaard  
Plaats : Uden (NL)  
1/1

Get. : R. Langens  
Schaal : 1:20  
Datum : 01-04-2014  
Wijz. :

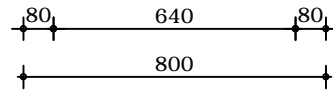
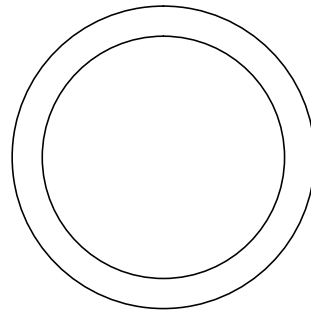

Bovenaanzicht

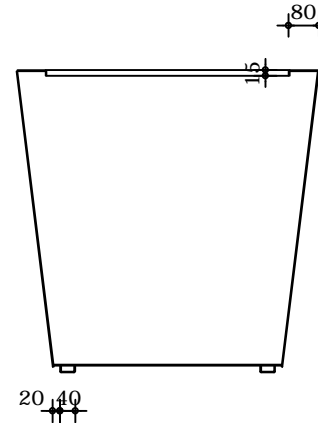

Verticale doorsnede

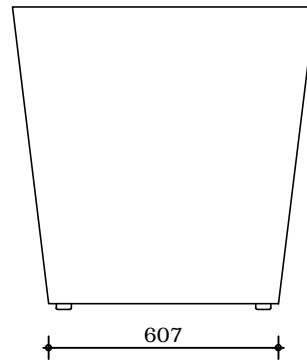

Vooraanzicht



Gewicht : 47kg  
Afwerking : Nvt

Omschrijving : Cado CC2  
Opdrachtgever : Adezz  
Werknummer : Standaard  
Plaats : Uden (NL)  
1/1

Get. : R. Langens  
Schaal : 1:20  
Datum : 01-04-2014  
Wijz. :

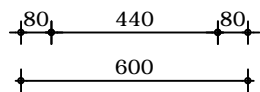
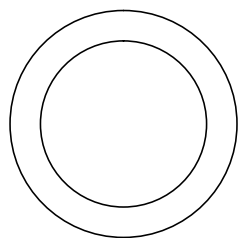

Bovenaanzicht

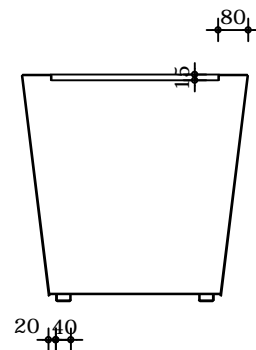

Verticale doorsnede

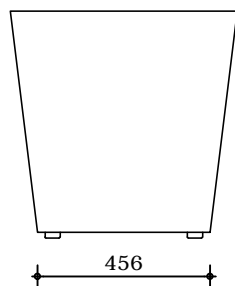

Vooraanzicht



Gewicht : 28kg  
Afwerking : Nvt

Omschrijving : Cado CC3  
Opdrachtgever : Adezz  
Werknummer : Standaard  
Plaats : Uden (NL)  
1/1

Get. : R. Langens  
Schaal : 1:20  
Datum : 01-04-2014  
Wijz. :

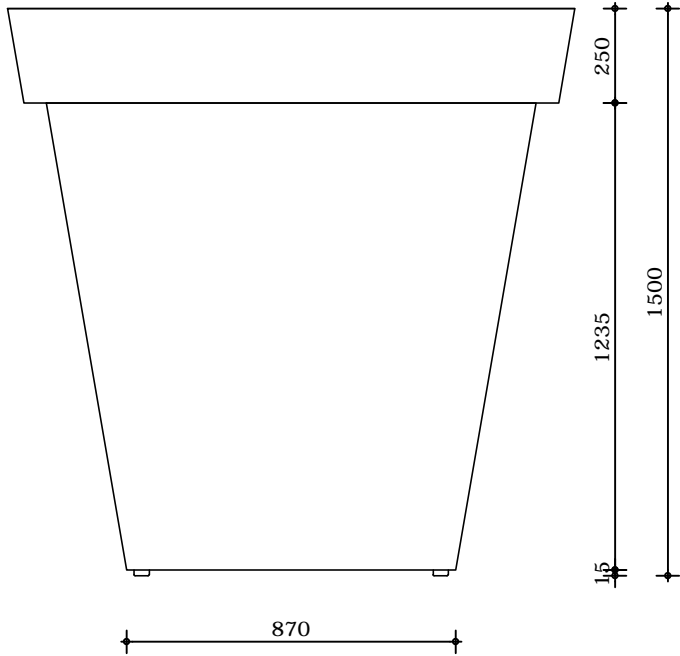

Vooraanzicht

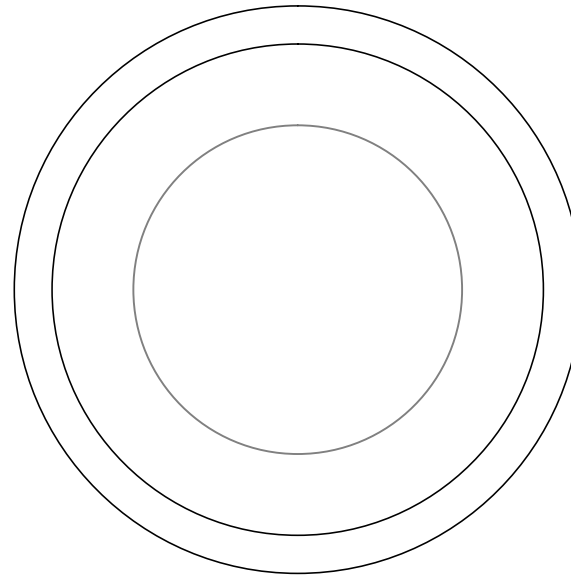

Bovenaanzicht

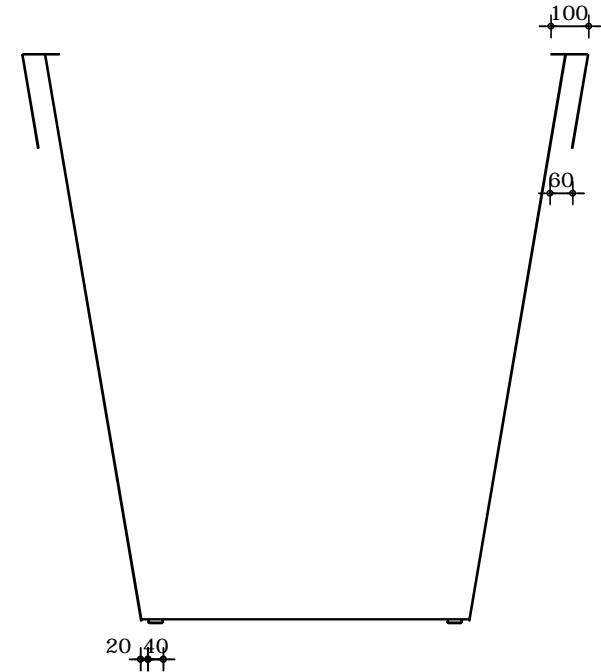

Doorsnede

Gewicht : 145kg  
 Afwerking : Nvt

Omschrijving : Celso CS1 Opdrachtgever : Adezz Werknummer : Standaard Plaats : Uden (NL) 1/1	Get. : R. Langens Schaal : 1:20 Datum : 01-04-2014 Wijz. :
--	---

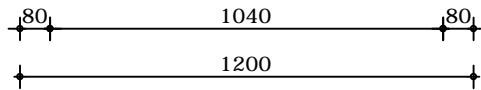
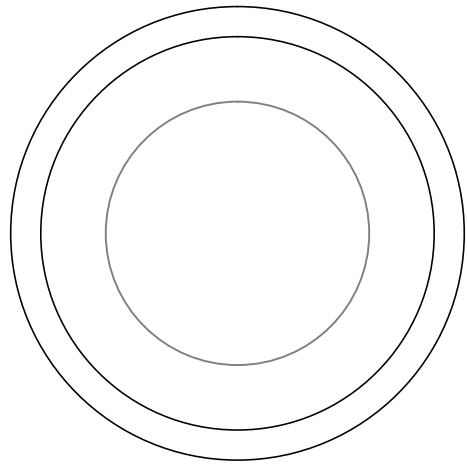

Bovenaanzicht

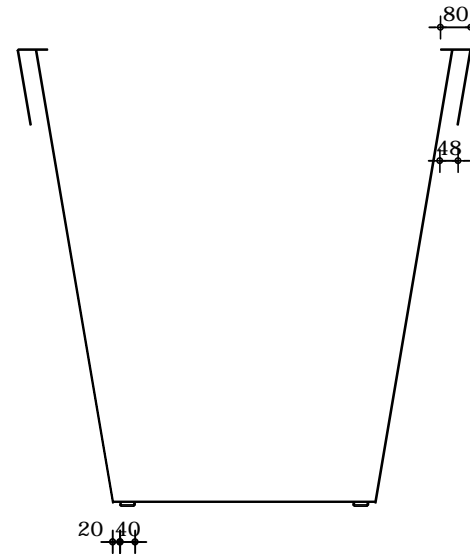

Doorsnede

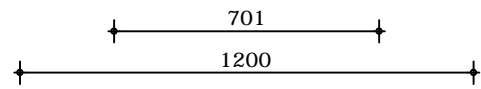
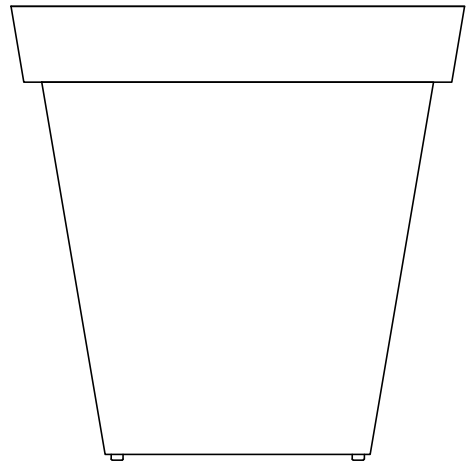

Vooraanzicht



Gewicht : 90kg  
Afwerking : Nvt

Omschrijving : Celso CS2  
Opdrachtgever : Adezz  
Werknummer : Standaard  
Plaats : Uden (NL)  
1/1

Get. : R. Langens  
Schaal : 1:20  
Datum : 01-04-2014  
Wijz. :

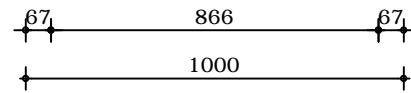
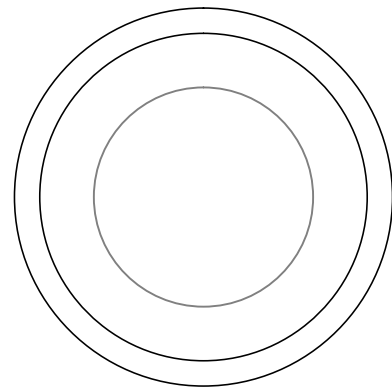

Bovenaanzicht

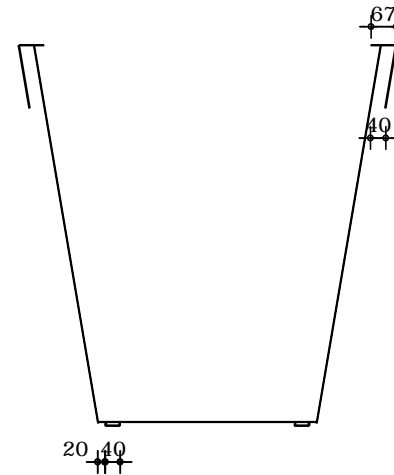

Doorsnede

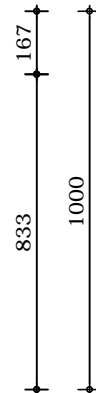
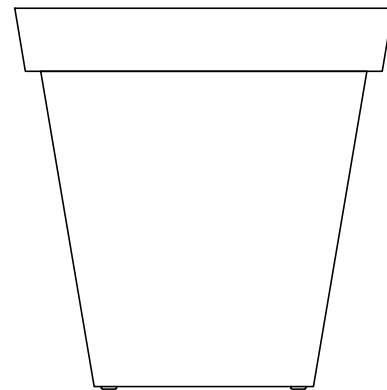

Voorbeeld

Gewicht : 59kg  
Afwerking : Nvt

Omschrijving : Celso CS3  
Opdrachtgever : Adezz  
Werknummer : Standaard  
Plaats : Uden (NL)  
1/1

Get. : R. Langens  
Schaal : 1:20  
Datum : 01-04-2014  
Wijz. :



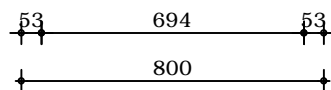
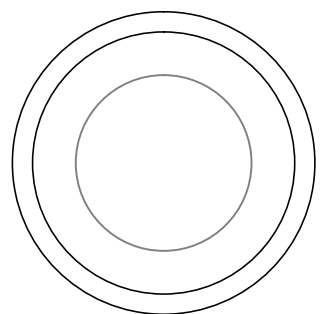

Bovenaanzicht

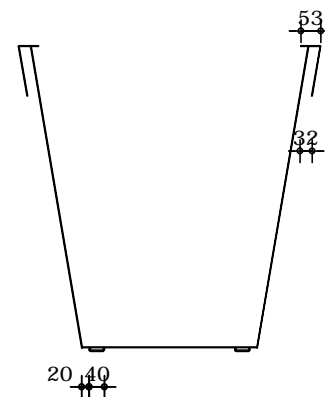

Doorsnede

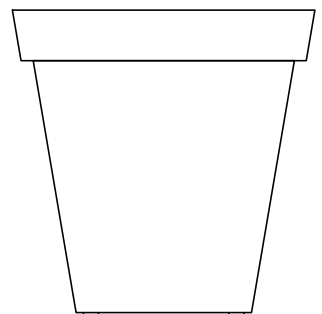

Vooraanzicht

Gewicht : 25kg  
Afwerking : Nvt

Omschrijving : Celso CS4  
Opdrachtgever : Adezz  
Werknummer : Standaard  
Plaats : Uden (NL)  
1/1

Get. : R. Langens  
Schaal : 1:20  
Datum : 01-04-2014  
Wijz. :

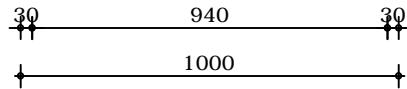
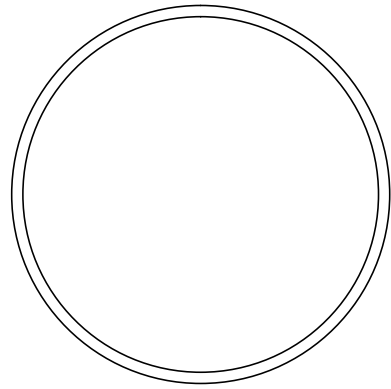

Bovenaanzicht

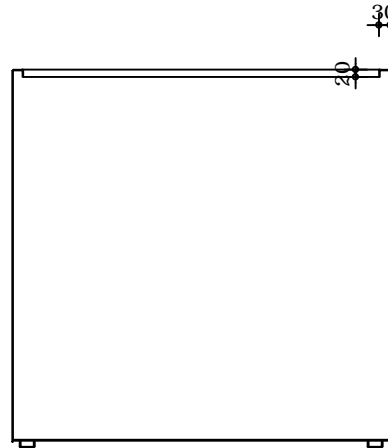

Verticale doorsnede

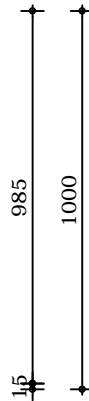
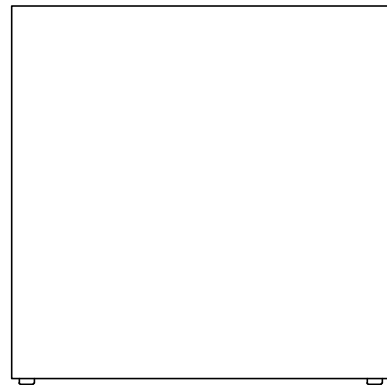

Vooraanzicht

Gewicht : 69kg  
Afwerking : Nvt

Omschrijving : Atlas CT1  
Opdrachtgever : Adezz  
Werknummer : Standaard  
Plaats : Uden (NL)  
1/1

Get. : R. Langens  
Schaal : 1:20  
Datum : 01-04-2014  
Wijz. :

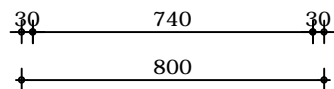
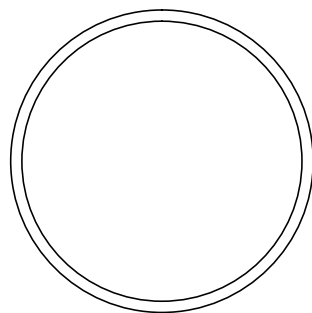

Bovenaanzicht

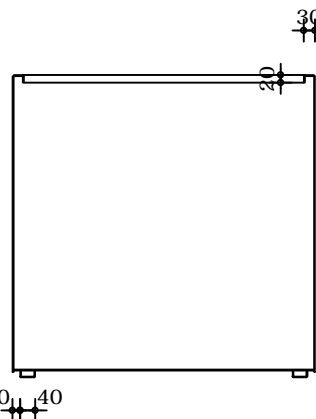

Verticale doorsnede

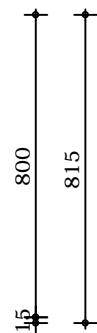
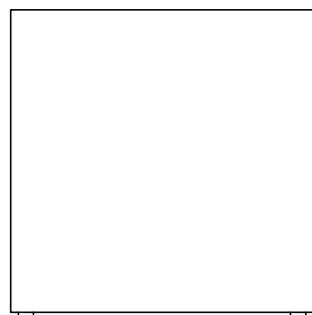

Vooraanzicht

Gewicht : 45kg  
Afwerking : Nvt

Omschrijving : Atlas CT2	Get. : R. Langens
Opdrachtgever : Adezz	Schaal : 1:20
Werknummer : Standaard	Datum : 01-04-2014
Plaats : Uden (NL)	Wijz. :
1/1	

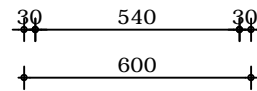
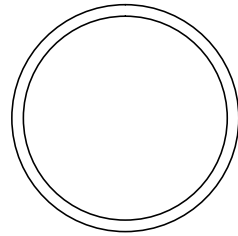

Bovenaanzicht

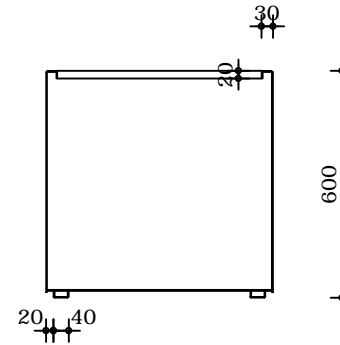

Verticale doorsnede

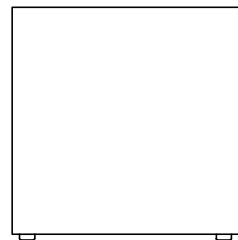

Vooraanzicht

Gewicht : 26kg  
Afwerking : Nvt

Omschrijving : Atlas CT3  
Opdrachtgever : Adezz  
Werknummer : Standaard  
Plaats : Uden (NL)  
1/1

Get. : R. Langens  
Schaal : 1:20  
Datum : 01-04-2014  
Wijz. :

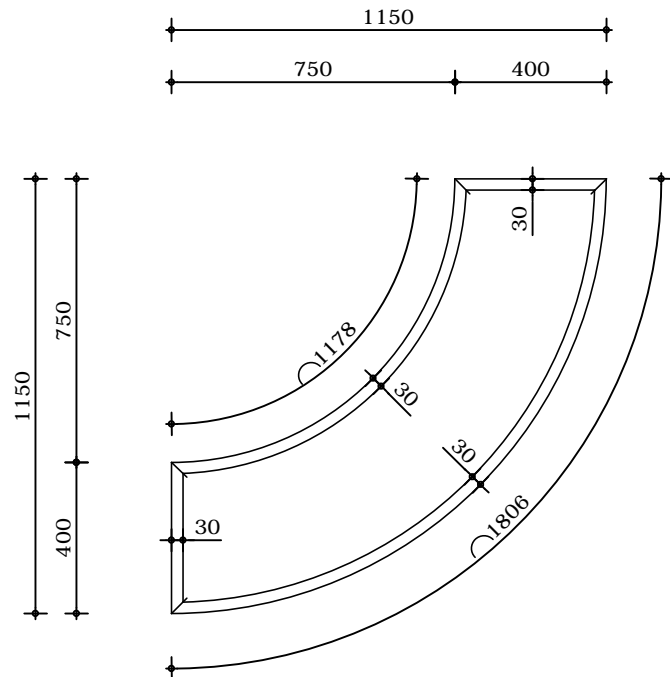

Bovenaanzicht

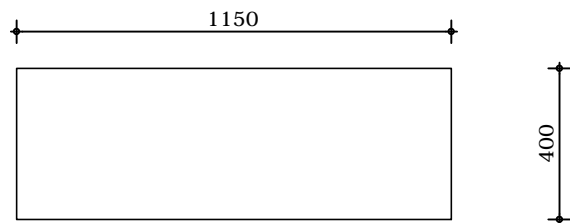

Vooraanzicht

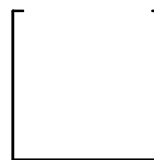

Verticale doorsnede

Gewicht : 60kg  
 Afwerking : Nvt

Omschrijving : Carpa CR1 Opdrachtgever : Adezz Werknummer : Standaard Plaats : Uden (NL) 1/1	Get. : R. Langens Schaal : 1:20 Datum : 01-04-2014 Wijz. :
--	---

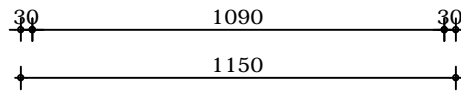
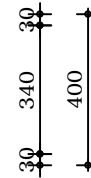
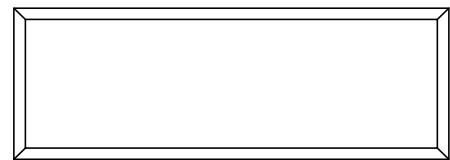

Bovenaanzicht

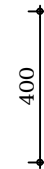
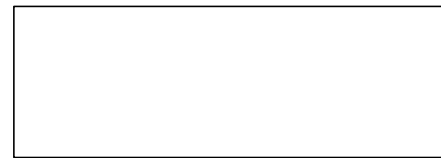

Voorbeeld

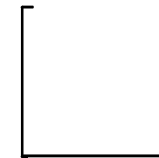

Verticale doorsnede

Gewicht : 45kg  
Afwerking : Nvt

Omschrijving : Carpa CR2  
Opdrachtgever : Adezz  
Werknummer : Standaard  
Plaats : Uden (NL)  
1/1

Get. : R. Langens  
Schaal : 1:20  
Datum : 01-04-2014  
Wijz. :

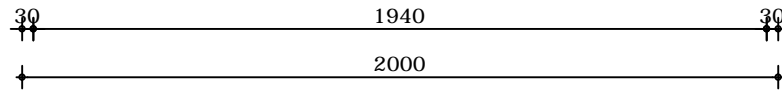
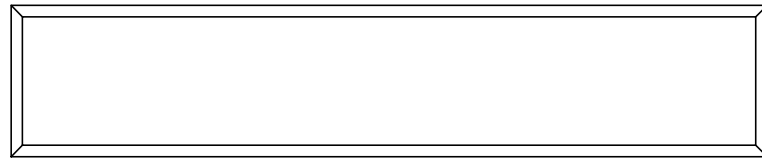

Bovenaanzicht

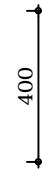

Vooraanzicht

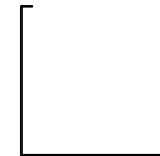

Verticale doorsnede

Gewicht : 72kg  
Afwerking : Nvt

Omschrijving : Carpa CR3  
Opdrachtgever : Adezz  
Werknummer : Standaard  
Plaats : Uden (NL)  
1/1

Get. : R. Langens  
Schaal : 1:20  
Datum : 01-04-2014  
Wijz. :

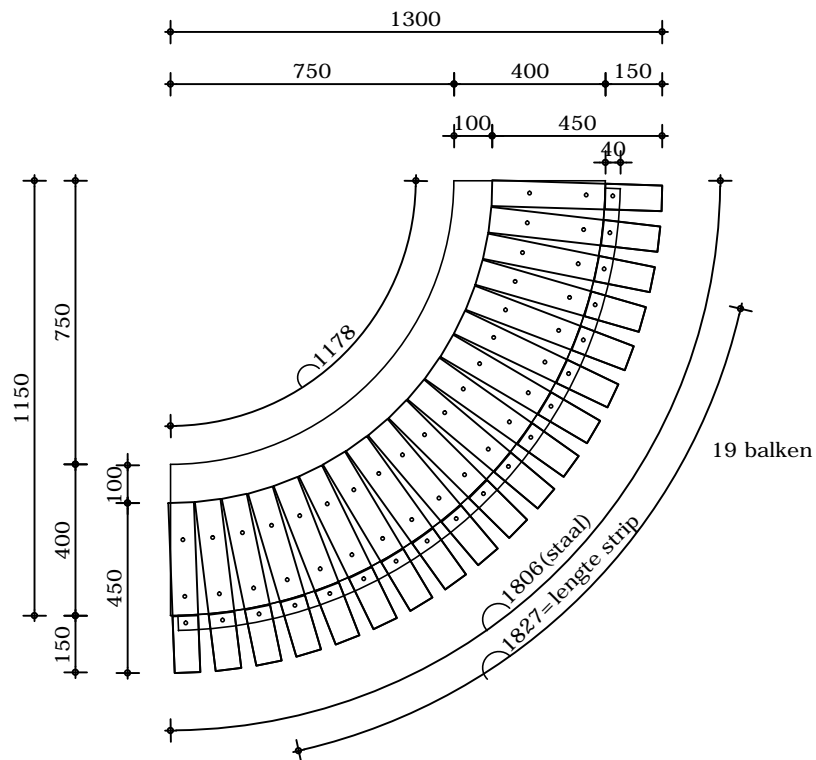

Bovenaanzicht

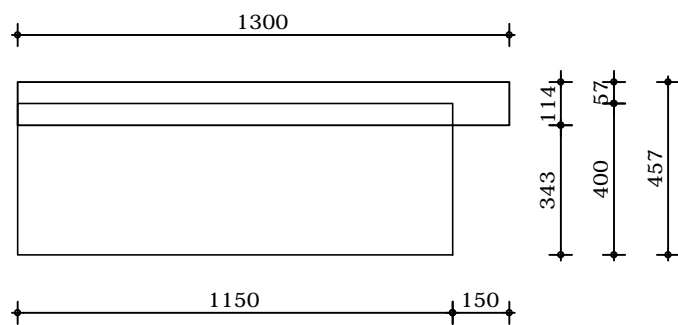

Vooraanzicht

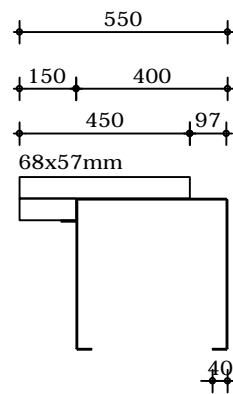

Verticale doorsnede

Gewicht : 96kg  
Afwerking : Nvt

Omschrijving : Carpa CRH1  
Opdrachtgever : Adezz  
Werknummer : Standaard  
Plaats : Uden (NL)  
1/1

Get. : R. Langens  
Schaal : 1:20  
Datum : 01-04-2014  
Wijz. :



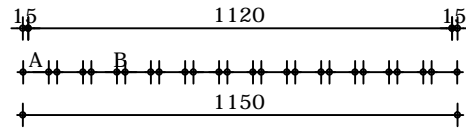
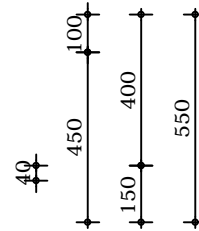
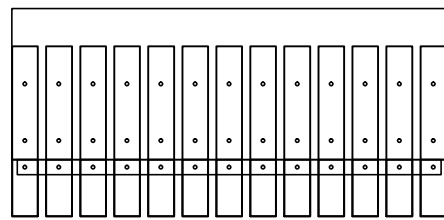

13xA A=68mm  
12xB B=12mm

Bovenaanzicht

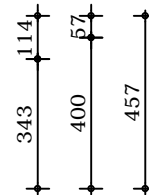
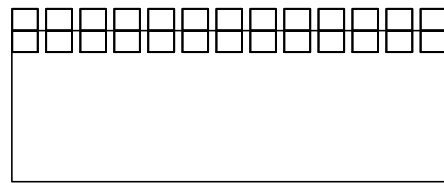

Voorbeeld

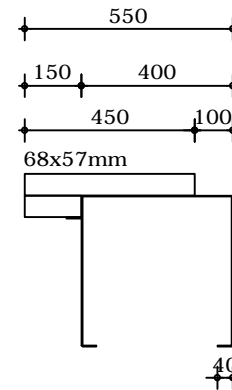

Verticale doorsnede

Gewicht : 93kg  
Afwerking : Nvt

Omschrijving : Carpa CRH2  
Opdrachtgever : Adezz  
Werknummer : Standaard  
Plaats : Uden (NL)  
1/1

Get. : R. Langens  
Schaal : 1:20  
Datum : 01-04-2014  
Wijz. :

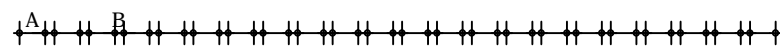
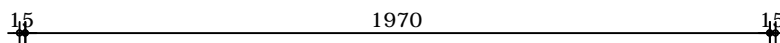
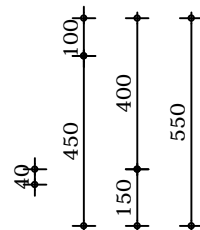

22xA A=68mm  
21xB B=24mm

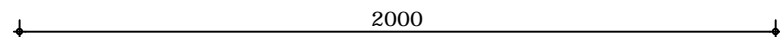

Bovenaanzicht

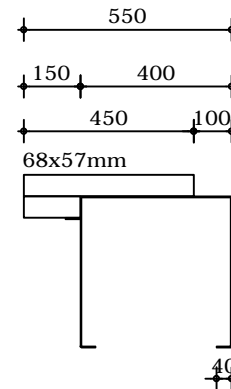
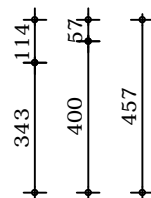
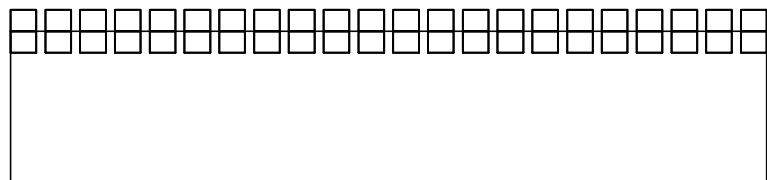

Verticale doorsnede

Vooraanzicht

Gewicht : 122kg  
Afwerking : Nvt

Omschrijving : Carpa CRH3  
Opdrachtgever : Adezz  
Werknummer : Standaard  
Plaats : Uden (NL)  
1/1

Get. : R. Langens  
Schaal : 1:20  
Datum : 01-04-2014  
Wijz. :

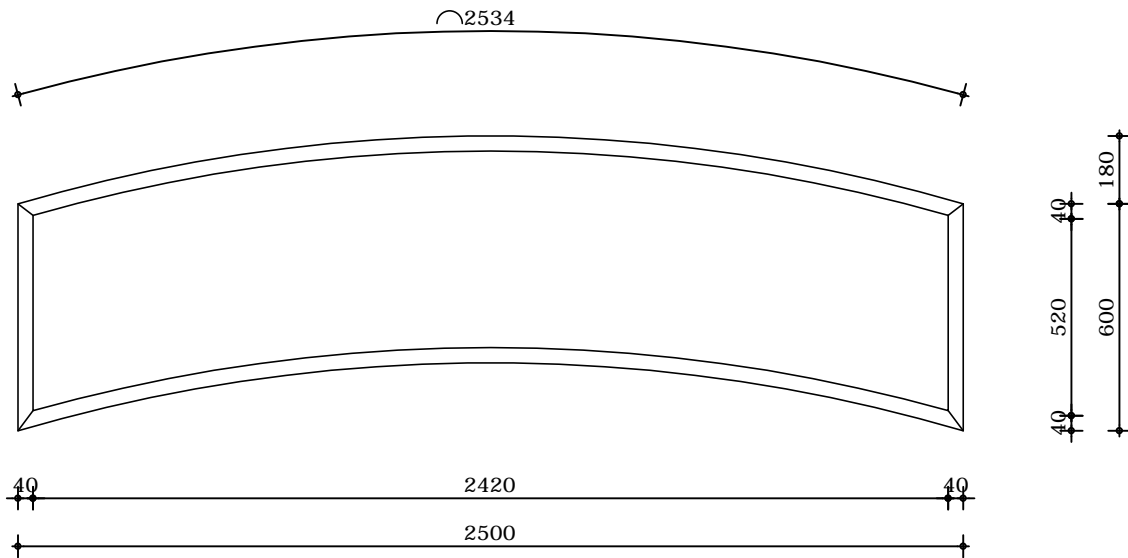

Bovenaanzicht

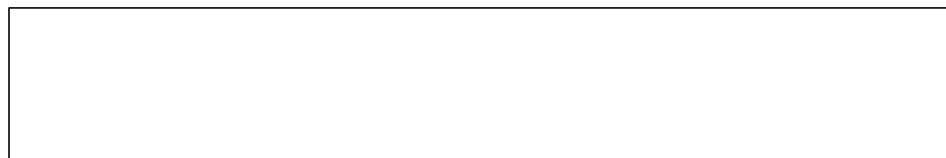

Vooraanzicht

400



Verticale doorsnede

Gewicht : 107kg  
Afwerking : Nvt

Omschrijving : Carva CV1  
Opdrachtgever : Adezz  
Werknummer : Standaard  
Plaats : Uden (NL)  
1/1

Get. : R. Langens  
Schaal : 1:20  
Datum : 01-04-2014  
Wijz. :

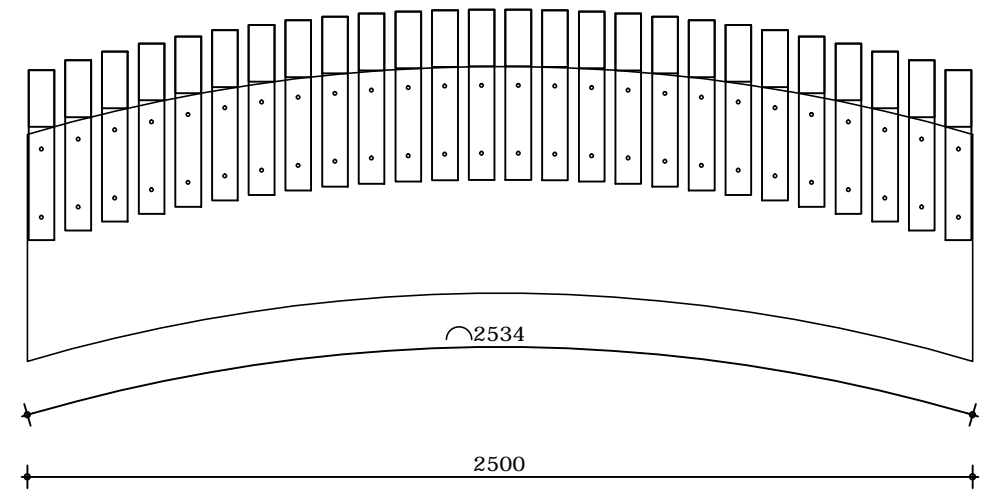

Bovenaanzicht

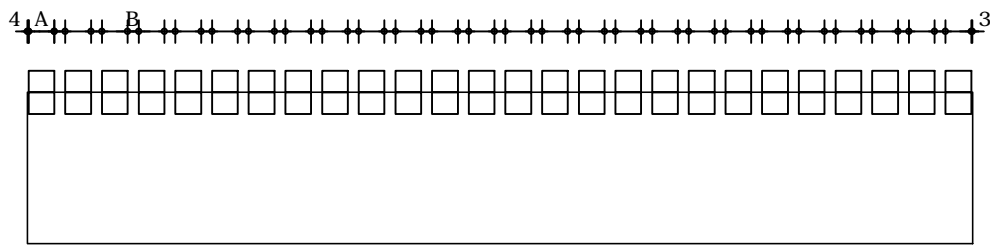

Vooraanzicht

26xA A=68mm  
25xB B=29mm

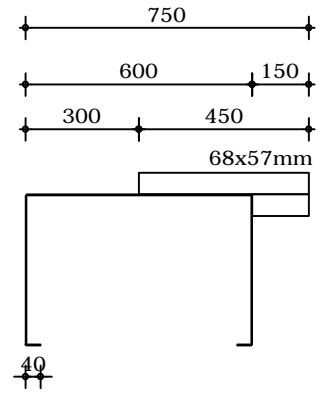

Verticale doorsnede

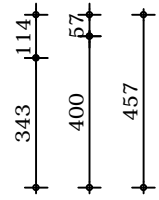

Gewicht : 242kg  
Afwerking : Nvt

<p>Omschrijving : Carva CVH1 Opdrachtgever : Adezz Werknummer : Standaard Plaats : Uden (NL) 1/1</p>	<p>Get. : R. Langens Schaal : 1:20 Datum : 01-04-2014 Wijz. :</p>
--	---