

Product Information: Aluminium planters

Aluminium is a light strong, durable material that is resistant to corrosion. The upper edge has been folded twice, which gives these planters a timeless and sturdy appearance. As standard, planters are made of 3mm thick Aluminium, although they can also be produced in 4-5mm. Each planter comes with 15mm feet, to slightly raise them from the ground.

Once constructed, the planter is powder coated with a strong adhesive primer and then finished with a scratch resistant coating.

Advantages:

- Strong / durable.
- Light in weight.
- Durable material.
- Scratch resistant coating.
- 5 year warranty.

Standard colour:

- RAL 7021 (all other RAL colors are possible).

Optional:

- Finishing in any RAL colour.
- Interior Application (waterproof indicate).
- FLORIDA can have recessed wheels.
- FLORIDA can come with feet (100X100X90mm height).
- Professional maintenance product available from us.



Customisation of the aluminium range means you can create stand out pieces matched to your size and colour requirements. Not only will aluminium suit any outdoor space they are also suitable for homes and offices.

Models: Cairo, Florida and Sydney

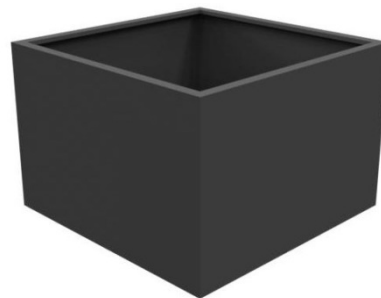

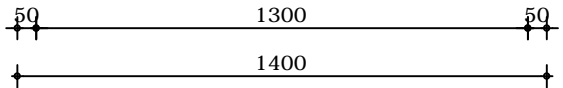
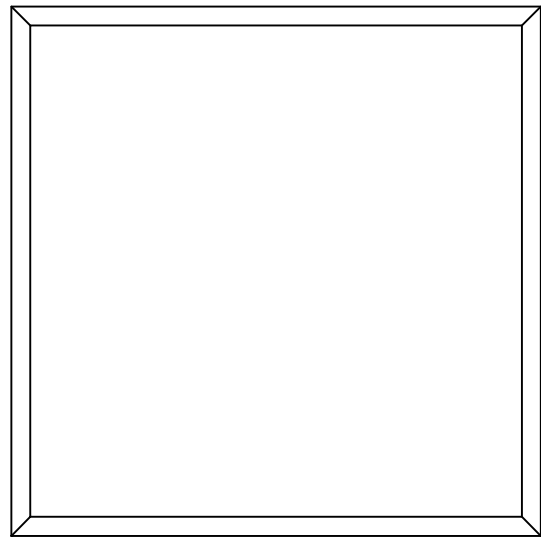

Bovenaanzicht

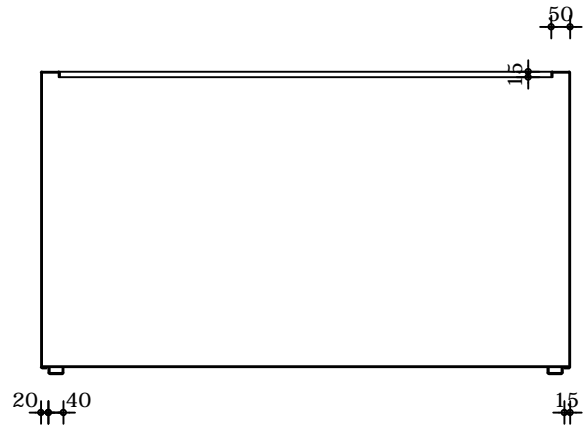

Verticale doorsnede

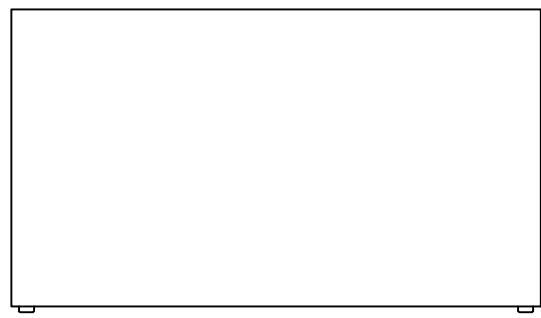

Vooraanzicht

Inhoud : 1.57m3
 Gewicht : 58kg
 Afwerking : RAL7021

Omschrijving : Florida AF1	Get. : R. Langens
Opdrachtgever : Adezz	Schaal : 1:20
Werknummer : Standaard	Datum : 01-04-2014
Plaats : Uden (NL)	Wijz. :
1/1	

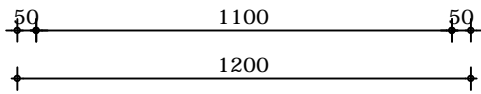
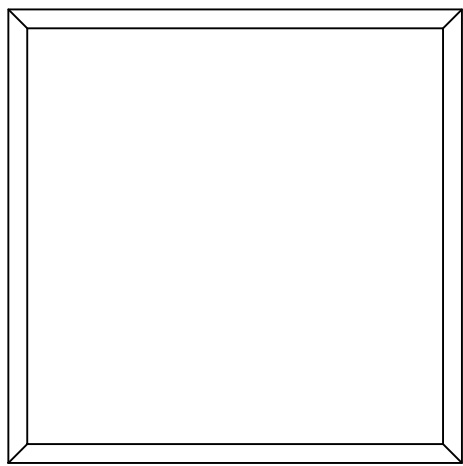

Bovenaanzicht

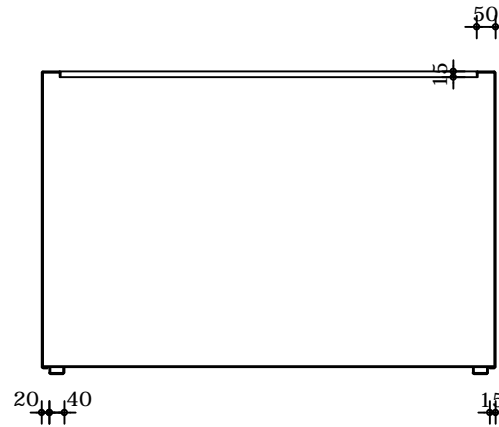

Verticale doorsnede

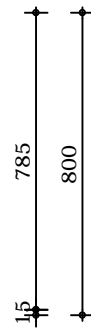
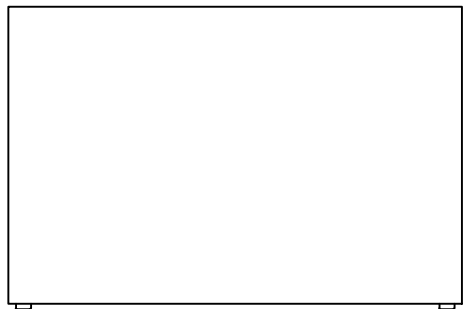

Vooraanzicht

Gewicht : 47kg
Afwerking : RAL7021

Omschrijving : Florida AF2
Opdrachtgever : Adezz
Werknummer : Standaard
Plaats : Uden (NL)
1/1

Get. : R. Langens
Schaal : 1:20
Datum : 01-04-2014
Wijz. :

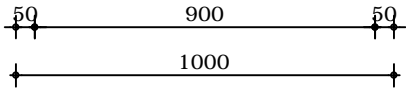
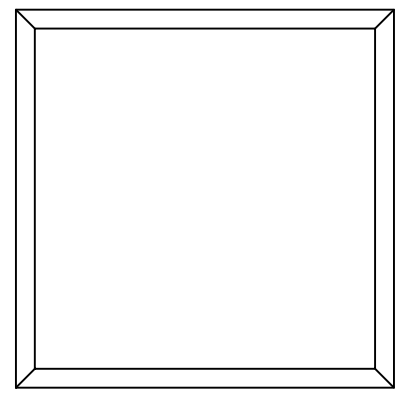

Bovenaanzicht

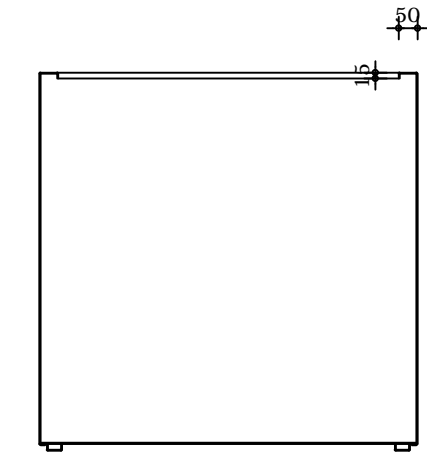
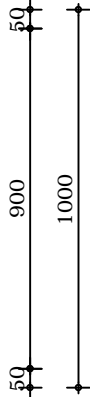

Verticale doorsnede

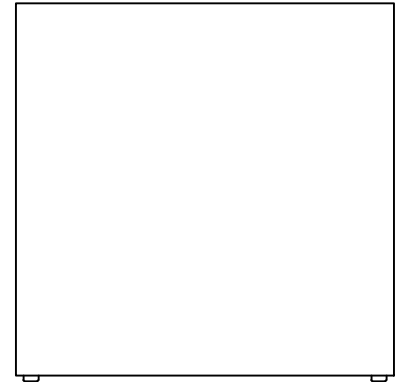

Vooraanzicht

Gewicht : 45kg
Afwerking : RAL7021

Omschrijving : Florida AF3	Get. : R. Langens
Opdrachtgever : Adezz	Schaal : 1:20
Werknummer : Standaard	Datum : 01-04-2014
Plaats : Uden (NL)	Wijz. :
1/1	

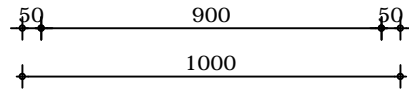
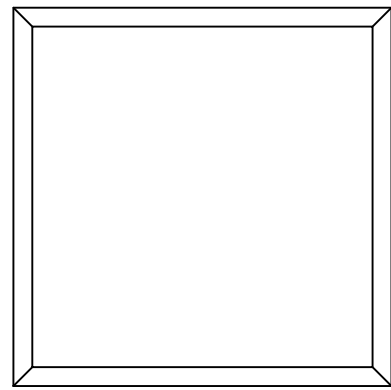

Bovenaanzicht

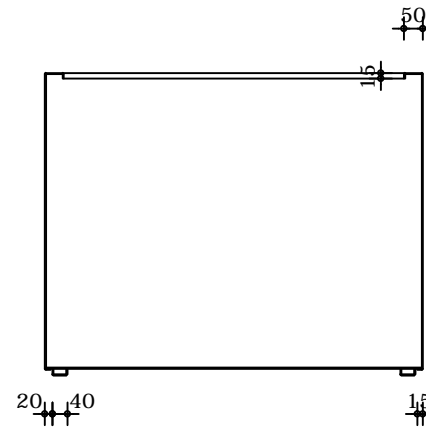

Verticale doorsnede

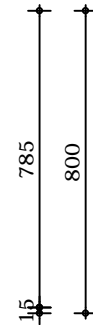
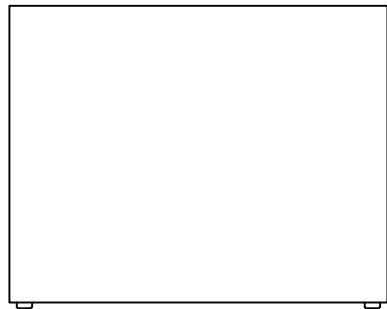

Vooraanzicht

Gewicht : 38kg
Afwerking : RAL7021

Omschrijving : Florida AF4	Get. : R. Langens
Opdrachtgever : Adezz	Schaal : 1:20
Werknummer : Standaard	Datum : 01-04-2014
Plaats : Uden (NL)	Wijz. :
1/1	

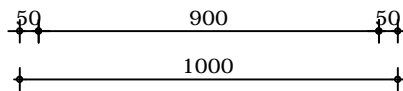
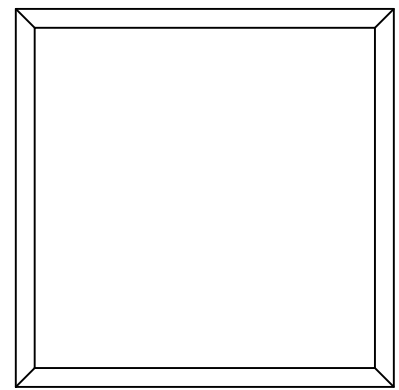

Bovenaanzicht

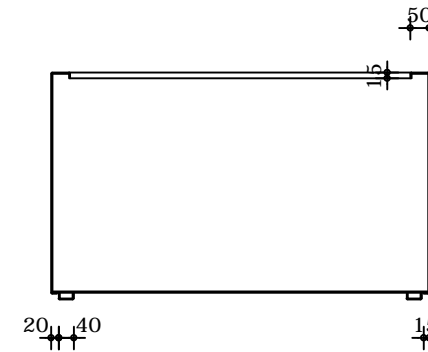
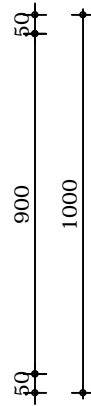

Verticale doorsnede



Vooraanzicht

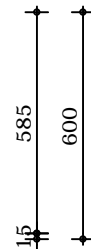

Gewicht : 30kg
Afwerking : RAL7021

Omschrijving : Florida AF4.1
Opdrachtgever : Adezz
Werknummer : Standaard
Plaats : Uden (NL)
1/1

Get. : R. Langens
Schaal : 1:20
Datum : 01-04-2014
Wijz. :

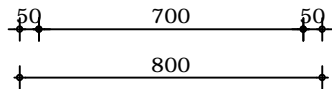
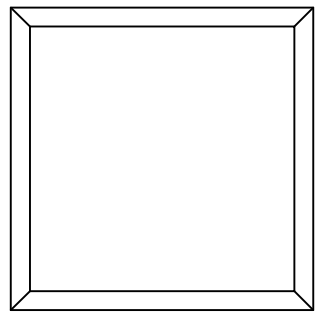

Bovenaanzicht

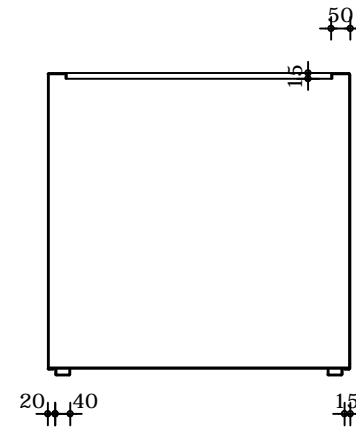

Verticale doorsnede

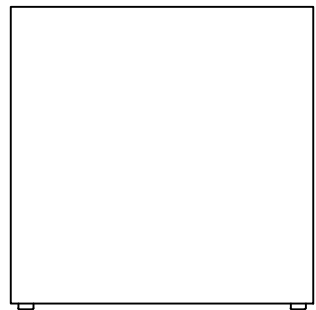

Vooraanzicht

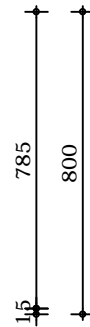

Gewicht : 29kg
Afwerking : RAL7021

Omschrijving : Florida AF5
Opdrachtgever : Adezz
Werknummer : Standaard
Plaats : Uden (NL)
1/1

Get. : R. Langens
Schaal : 1:20
Datum : 01-04-2014
Wijz. :

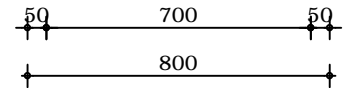
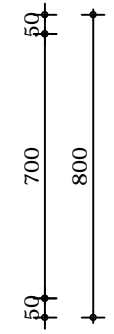
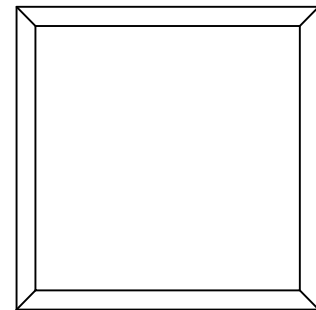

Bovenaanzicht

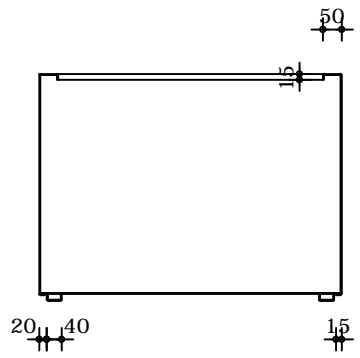

Verticale doorsnede

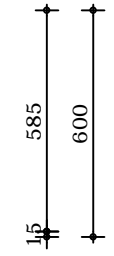
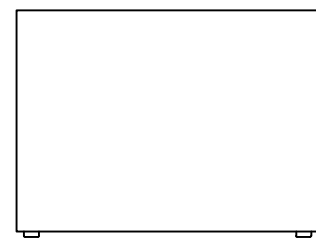

Voorraanzicht

Gewicht : 23kg
Afwerking : RAL7021

Omschrijving : Florida AF5.1	Get. : R. Langens
Opdrachtgever : Adezz	Schaal : 1:20
Werknummer : Standaard	Datum : 01-04-2014
Plaats : Uden (NL)	Wijz. :
1/1	

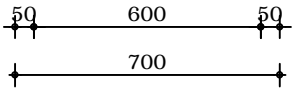
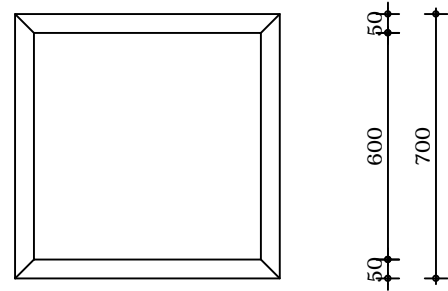

Bovenaanzicht

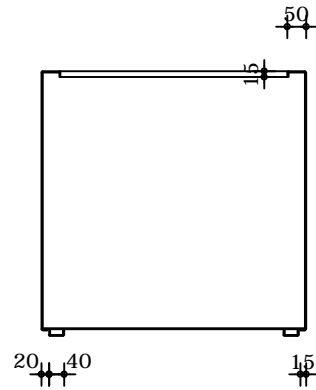

Verticale doorsnede

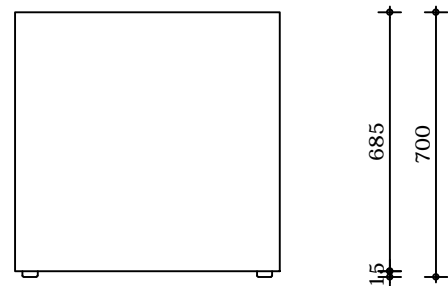

Vooraanzicht

Gewicht : 22kg
 Afwerking : RAL7021

<p>Omschrijving : Florida AF6 Opdrachtgever : Adezz Werknummer : Standaard Plaats : Uden (NL) 1/1</p>	<p>Get. : R. Langens Schaal : 1:20 Datum : 01-04-2014 Wijz. :</p>
---	--

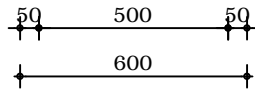
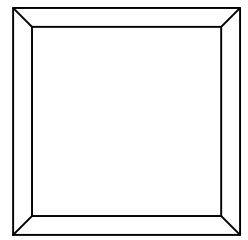

Bovenaanzicht

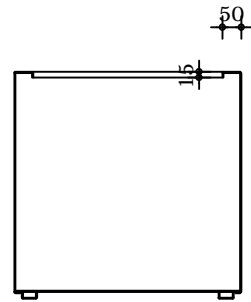

Verticale doorsnede

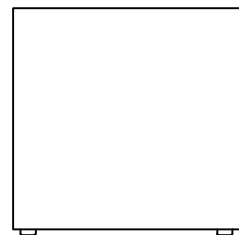

Vooraanzicht

Gewicht : 16kg
Afwerking : RAL7021

Omschrijving : Florida AF7
Opdrachtgever : Adezz
Werknummer : Standaard
Plaats : Uden (NL)
1/1

Get. : R. Langens
Schaal : 1:20
Datum : 01-04-2014
Wijz. :

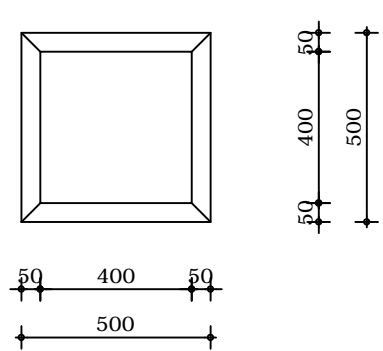

Bovenaanzicht

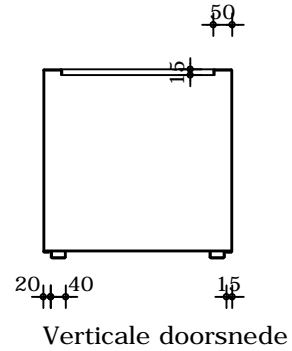

Verticale doorsnede

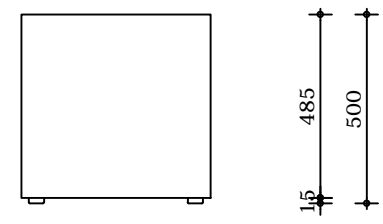

Vooraanzicht

Gewicht : 12kg
 Afwerking : RAL7021

Omschrijving : Florida AF8 Opdrachtgever : Adezz Werknummer : Standaard Plaats : Uden (NL) 1/1	Get. : R. Langens Schaal : 1:20 Datum : 01-04-2014 Wijz. :
--	---

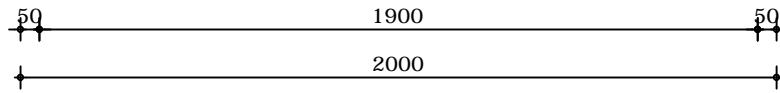
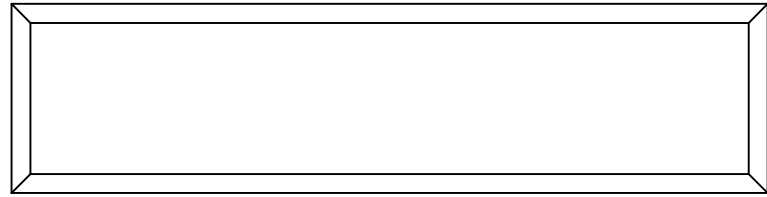

Bovenaanzicht

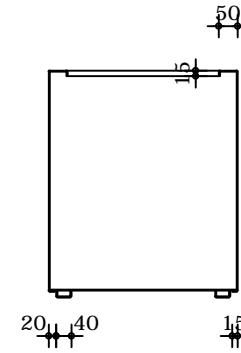

Verticale doorsnede

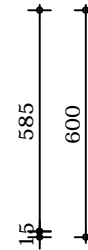

Vooraanzicht

Gewicht : 37kg
Afwerking : RAL7021

Omschrijving : Florida AF9
Opdrachtgever : Adezz
Werknummer : Standaard
Plaats : Uden (NL)
1/1

Get. : R. Langens
Schaal : 1:20
Datum : 01-04-2014
Wijz. :

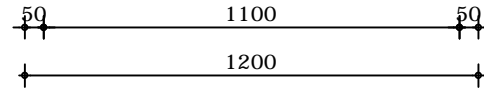
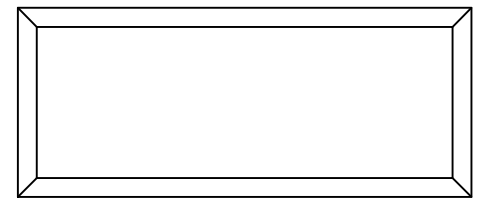

Bovenaanzicht

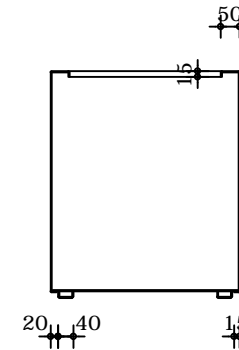

Verticale doorsnede



Vooraanzicht

Gewicht : 29kg
Afwerking : RAL7021

Omschrijving : Florida AF10
Opdrachtgever : Adezz
Werknummer : Standaard
Plaats : Uden (NL)
1/1

Get. : R. Langens
Schaal : 1:20
Datum : 01-04-2014
Wijz. :

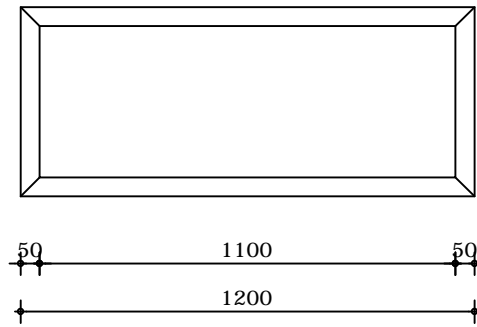

Bovenaanzicht

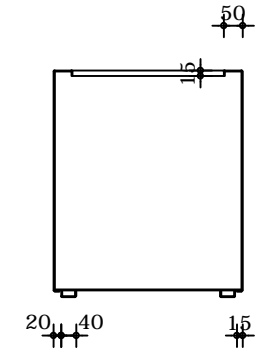

Verticale doorsnede

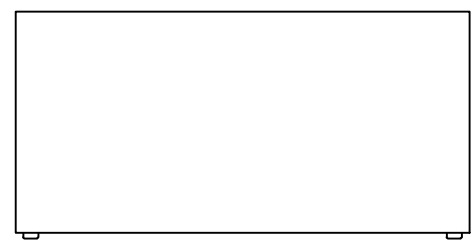

Vooraanzicht



Gewicht : 24kg
 Afwerking : RAL7021

Omschrijving : Florida AF11 Opdrachtgever : Adezz Werknummer : Standaard Plaats : Uden (NL) 1/1	Get. : R. Langens Schaal : 1:20 Datum : 01-04-2014 Wijz. :
---	---

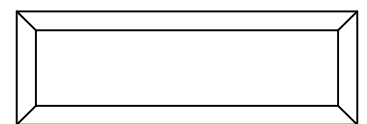

50
200
50
300

50 800 50
900

Bovenaanzicht

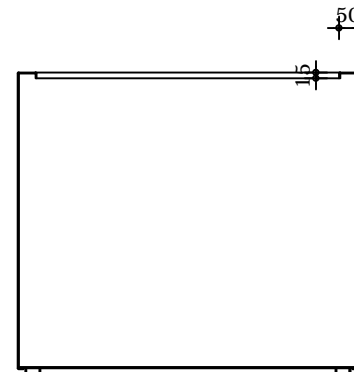

20 40

50

15

Verticale doorsnede

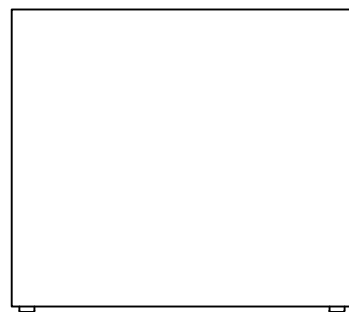

785
800
15

Vooraanzicht

Gewicht : 20kg
Afwerking : RAL7021

Omschrijving : Florida AF12
Opdrachtgever : Adezz
Werknummer : Standaard
Plaats : Uden (NL)
1/1

Get. : R. Langens
Schaal : 1:20
Datum : 01-04-2014
Wijz. :

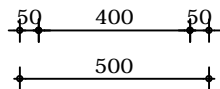
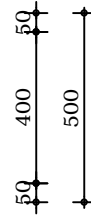
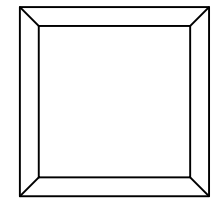

Bovenaanzicht

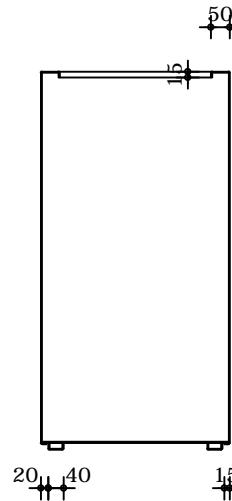

Verticale doorsnede



Vooraanzicht

Gewicht : 20kg
Afwerking : RAL7021

Omschrijving : Florida AF13	Get. : R. Langens
Opdrachtgever : Adezz	Schaal : 1:20
Werknummer : Standaard	Datum : 01-04-2014
Plaats : Uden (NL)	Wijz. :
1/1	

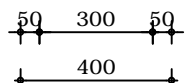
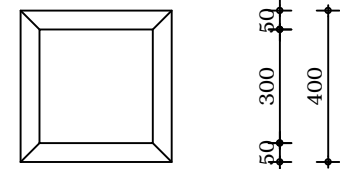

Bovenaanzicht

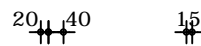
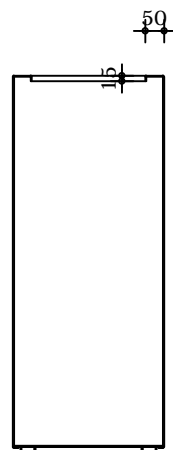

Verticale doorsnede

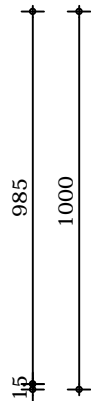
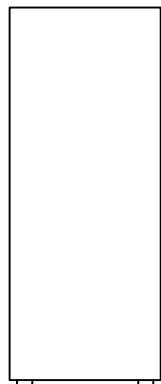

Vooraanzicht

Gewicht : 16kg
Afwerking : RAL7021

Omschrijving : Florida AF14
Opdrachtgever : Adezz
Werknummer : Standaard
Plaats : Uden (NL)
1/1

Get. : R. Langens
Schaal : 1:20
Datum : 01-04-2014
Wijz. :

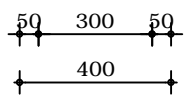
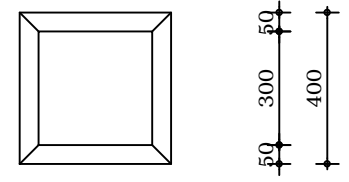

Bovenaanzicht

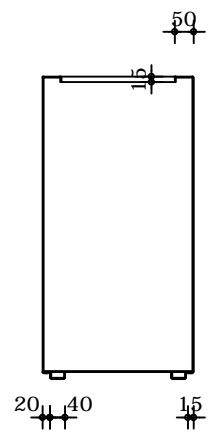

Verticale doorsnede

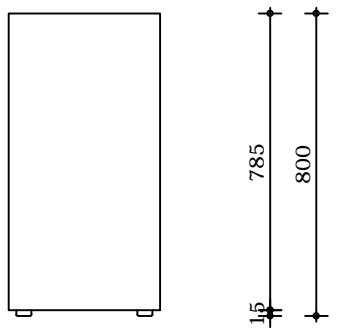

Voorraanzicht

Gewicht : 13kg
 Afwerking : RAL7021

Omschrijving : Florida AF15	Get. : R. Langens
Opdrachtgever : Adezz	Schaal : 1:20
Werknummer : Standaard	Datum : 01-04-2014
Plaats : Uden (NL)	Wijz. :
1/1	

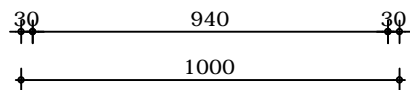
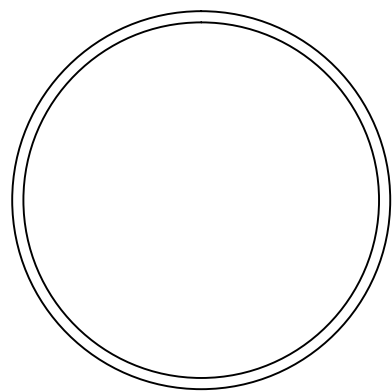

Bovenaanzicht

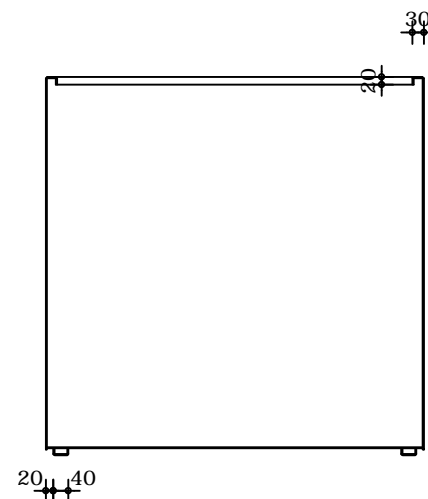

Verticale doorsnede

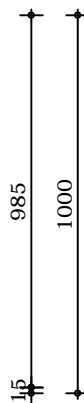
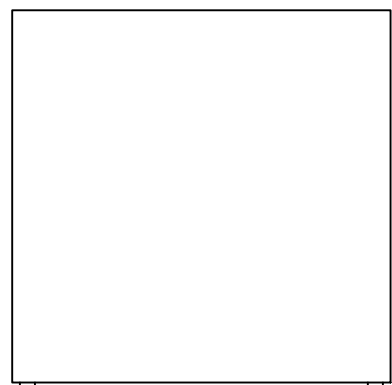

Vooraanzicht

Gewicht : 36kg
Afwerking : RAL7021

Omschrijving : Sydney AM1
Opdrachtgever : Adezz
Werknummer : Standaard
Plaats : Uden (NL)
1/1

Get. : R. Langens
Schaal : 1:20
Datum : 01-04-2014
Wijz. :

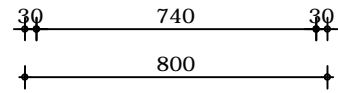
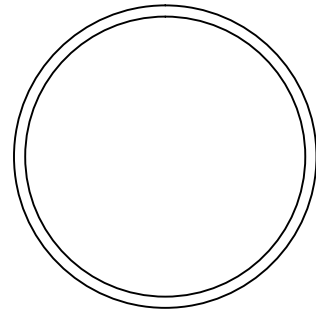

Bovenaanzicht

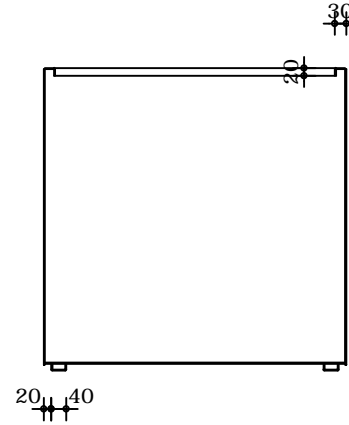

Verticale doorsnede

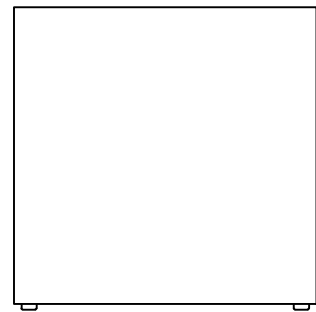

Vooraanzicht

Gewicht : 24kg
Afwerking : RAL7021

Omschrijving : Sydney AM2
Opdrachtgever : Adezz
Werknummer : Standaard
Plaats : Uden (NL)
1/1

Get. : R. Langens
Schaal : 1:20
Datum : 01-04-2014
Wijz. :

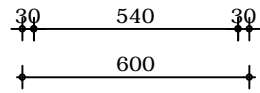
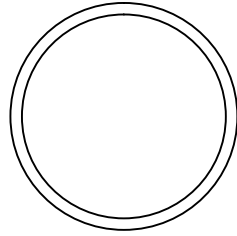

Bovenaanzicht

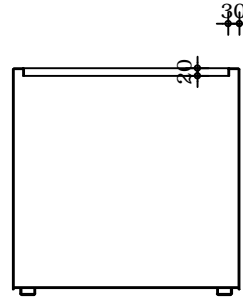

Verticale doorsnede

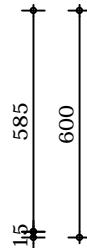
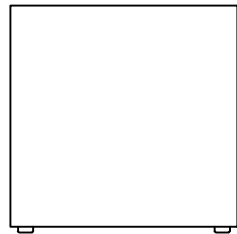

Vooraanzicht

Gewicht : 13kg
Afwerking : RAL7021

Omschrijving : Sydney AM3
Opdrachtgever : Adezz
Werknummer : Standaard
Plaats : Uden (NL)
1/1

Get. : R. Langens
Schaal : 1:20
Datum : 01-04-2014
Wijz. :

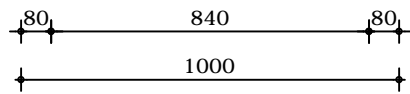
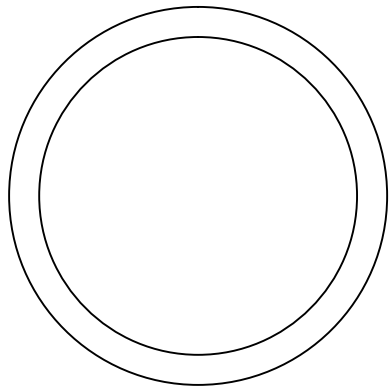

Bovenaanzicht

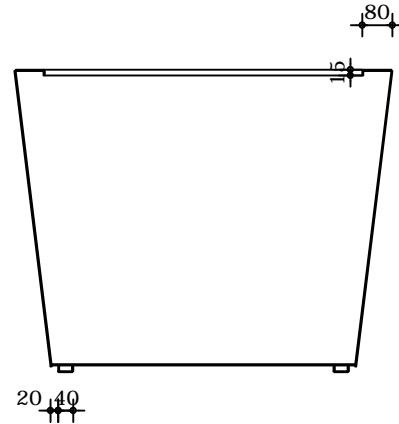

Verticale doorsnede

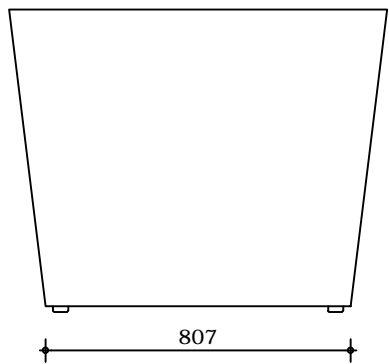

Vooraanzicht

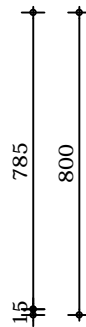

Gewicht : 31kg
Afwerking : RAL7021

Omschrijving : Cairo AC1
Opdrachtgever : Adezz
Werknummer : Standaard
Plaats : Uden (NL)
1/1

Get. : R. Langens
Schaal : 1:20
Datum : 01-04-2014
Wijz. :

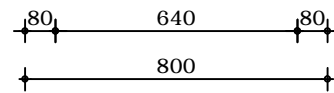
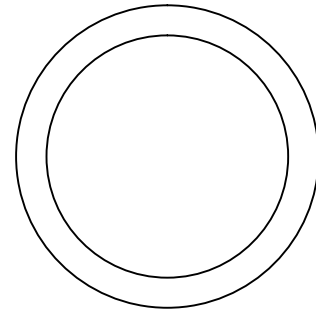

Bovenaanzicht

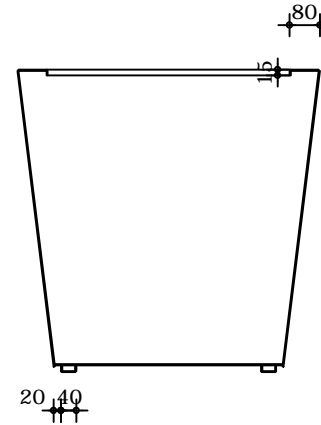

Verticale doorsnede

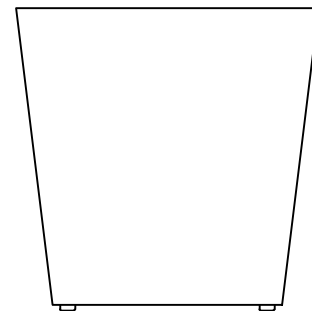

Vooraanzicht

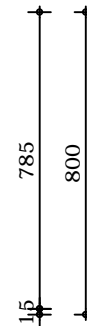

Gewicht : 23kg
Afwerking : RAL7021

Omschrijving : Cairo AC2
Opdrachtgever : Adezz
Werknummer : Standaard
Plaats : Uden (NL)
1/1

Get. : R. Langens
Schaal : 1:20
Datum : 01-04-2014
Wijz. :

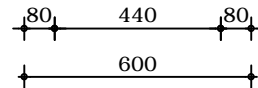
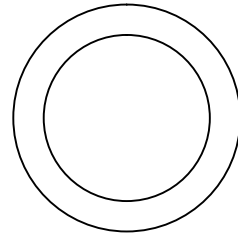

Bovenaanzicht

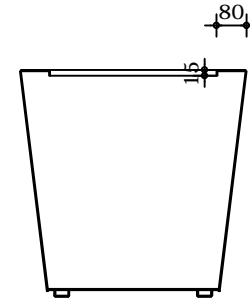

Verticale doorsnede

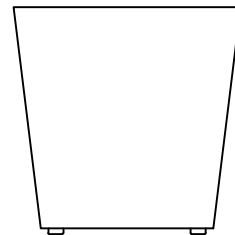

Vooraanzicht

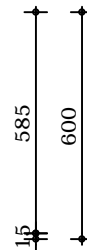

Gewicht : 13kg
Afwerking : RAL7021

Omschrijving : Cairo AC3
Opdrachtgever : Adezz
Werknummer : Standaard
Plaats : Uden (NL)
1/1

Get. : R. Langens
Schaal : 1:20
Datum : 01-04-2014
Wijz. :

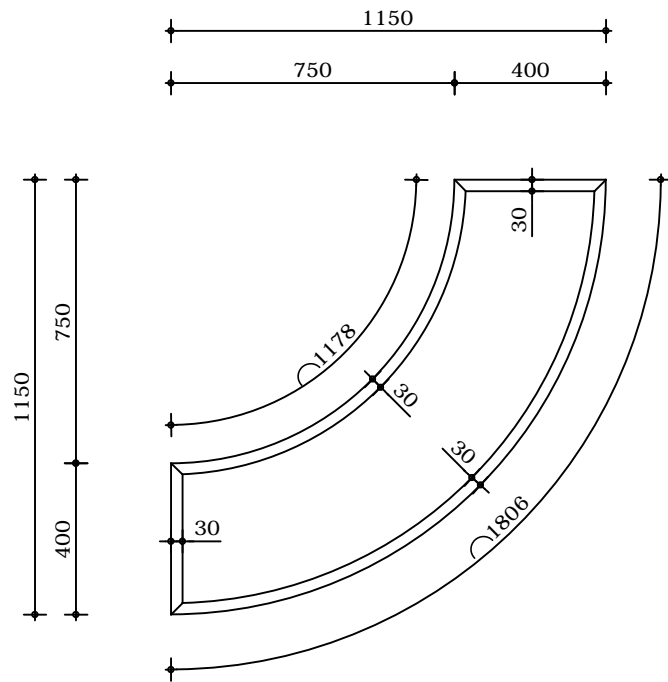

Bovenaanzicht

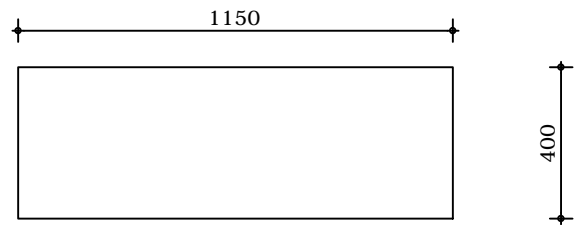

Vooraanzicht

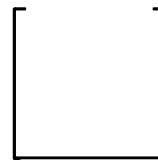

Verticale doorsnede

Gewicht : 28kg
 Afwerking : RAL7021

Omschrijving : Alma AR1 Opdrachtgever : Adezz Werknummer : Standaard Plaats : Uden (NL) 1/1	Get. : R. Langens Schaal : 1:20 Datum : 01-04-2014 Wijz. :
---	---

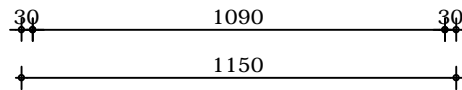
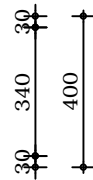
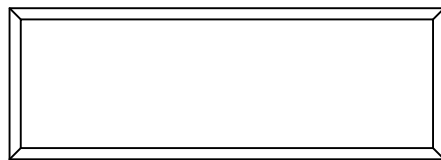

Bovenaanzicht

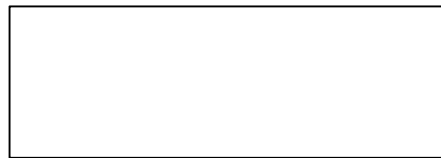

Voorbeeld



Verticale doorsnede

Gewicht : 21kg
Afwerking : RAL7021

Omschrijving : Alma AR2
Opdrachtgever : Adezz
Werknummer : Standaard
Plaats : Uden (NL)
1/1

Get. : R. Langens
Schaal : 1:20
Datum : 01-04-2014
Wijz. :

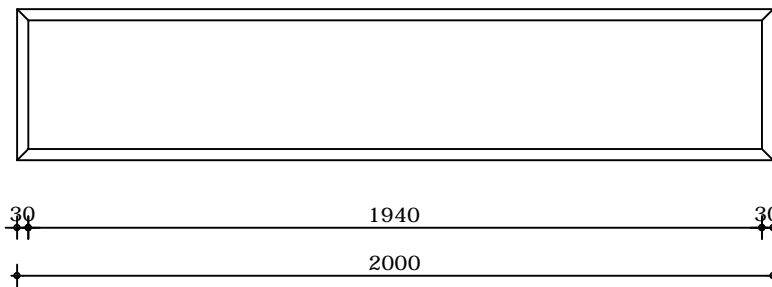

Bovenaanzicht



Vooraanzicht

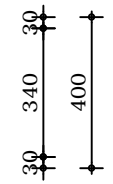

Verticale doorsnede

Gewicht : 34kg
 Afwerking : RAL7021

Omschrijving : Alma AR3	Get. : R. Langens
Opdrachtgever : Adezz	Schaal : 1:20
Werknummer : Standaard	Datum : 01-04-2014
Plaats : Uden (NL)	Wijz. :
1/1	

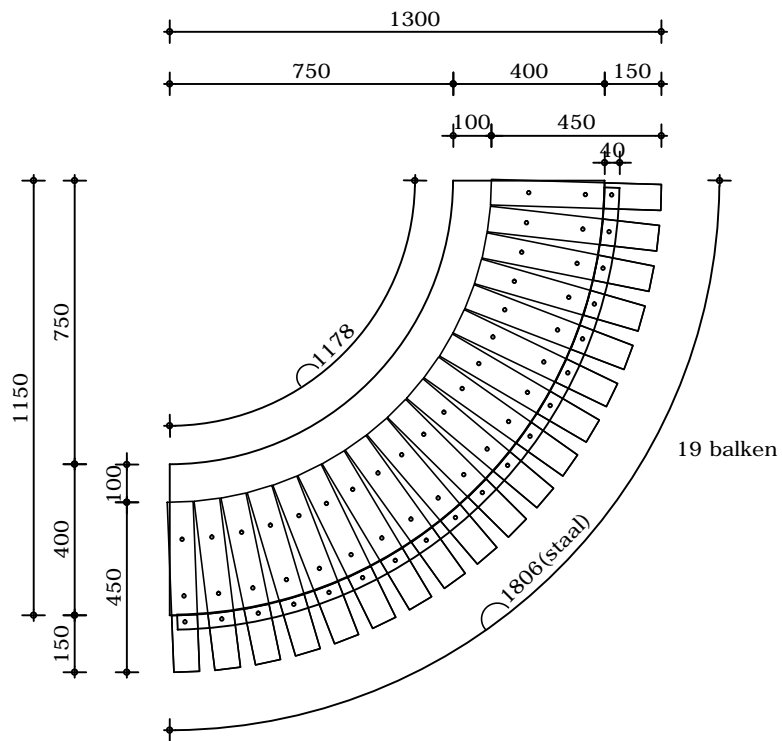

Bovenaanzicht

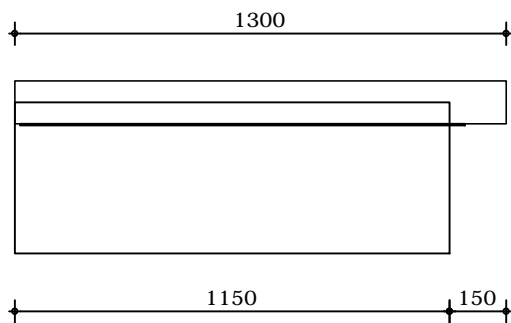

Vooraanzicht

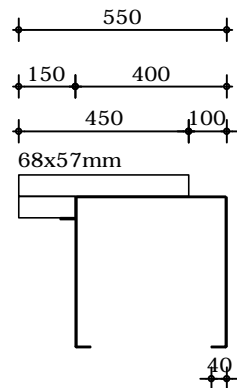

Verticale doorsnede

Gewicht : 100kg
Afwerking : RAL7021

Omschrijving : Alma ARH1	Get. : R. Langens
Opdrachtgever : Adezz	Schaal : 1:20
Werknummer : Standaard	Datum : 01-04-2014
Plaats : Uden (NL)	Wijz. :
1/1	

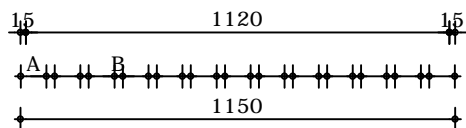
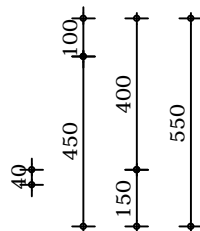

13xA A=68mm
12xB B=12mm

Bovenaanzicht

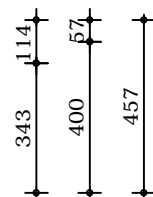
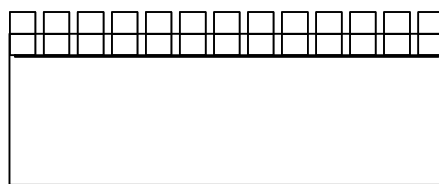

Vooraanzicht

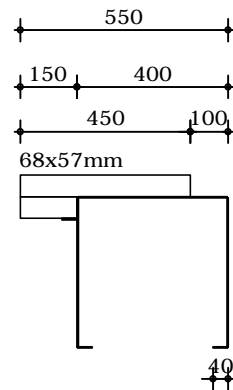

Verticale doorsnede

Gewicht : 69kg
Afwerking : RAL7021

Omschrijving : Alma ARH2
Opdrachtgever : Adezz
Werknummer : Standaard
Plaats : Uden (NL)
1/1

Get. : R. Langens
Schaal : 1:20
Datum : 01-04-2014
Wijz. :

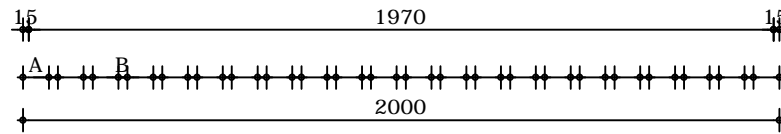
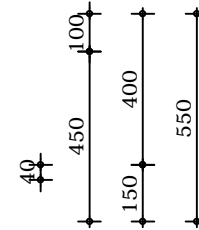
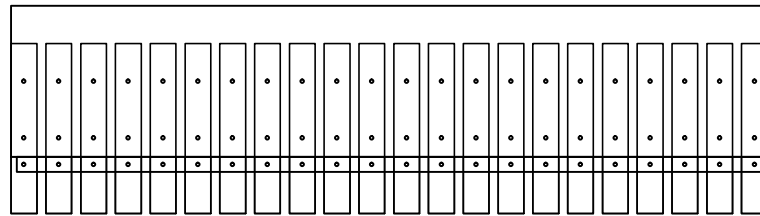

22xA A= 68mm
21xB B= 24mm

Bovenaanzicht

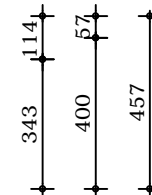
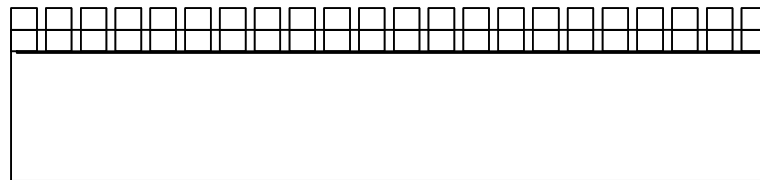

Vooraanzicht

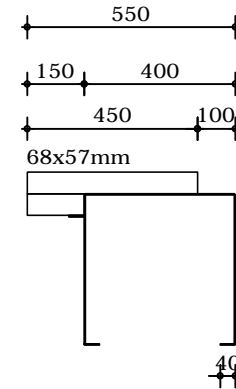

Verticale doorsnede

Gewicht : 120kg
Afwerking : RAL7021

<p>Omschrijving : Alma ARH3 Opdrachtgever : Adezz Werknummer : Standaard Plaats : Uden (NL) 1/1</p>	<p>Get. : R. Langens Schaal : 1:20 Datum : 01-04-2014 Wijz. :</p>
---	---

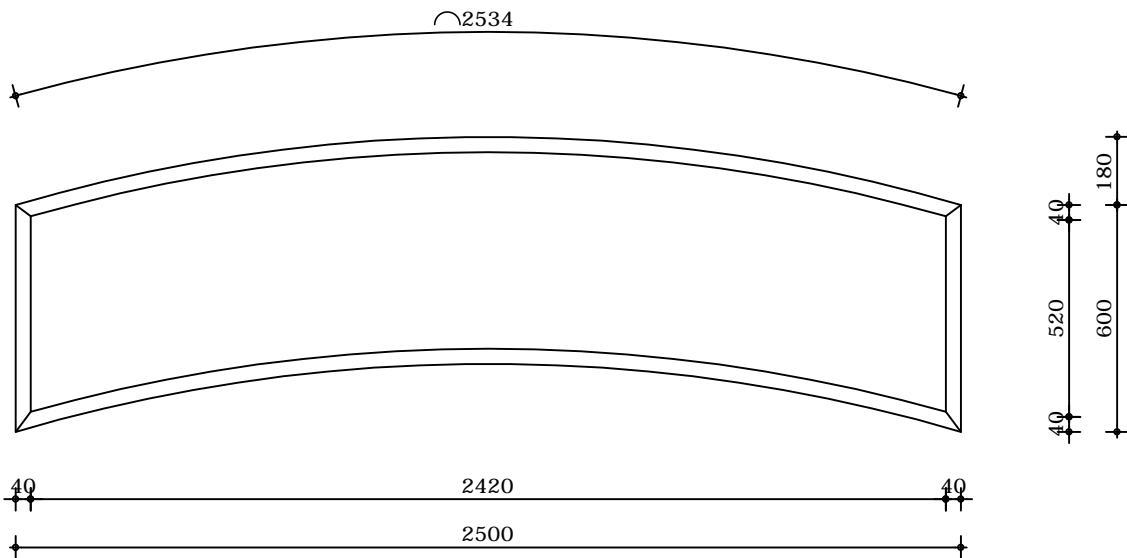

Bovenaanzicht

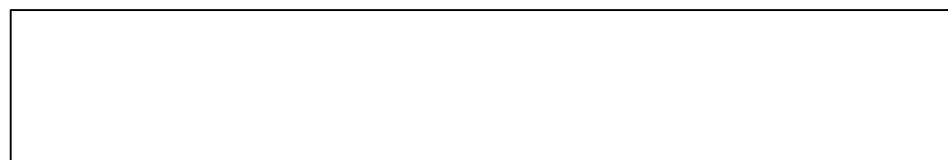

Vooraanzicht

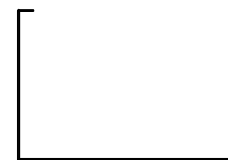

Verticale doorsnede

Gewicht : 50kg
 Afwerking : RAL7021

<p>Omschrijving : Alva AV1 Opdrachtgever : Adezz Werknummer : Standaard Plaats : Uden (NL) 1/1</p>	<p>Get. : R. Langens Schaal : 1:20 Datum : 01-04-2014 Wijz. :</p>
--	--

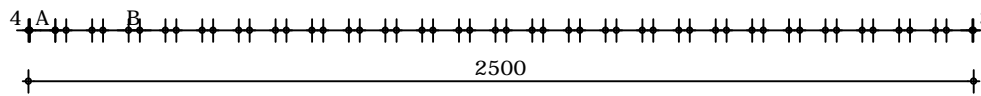
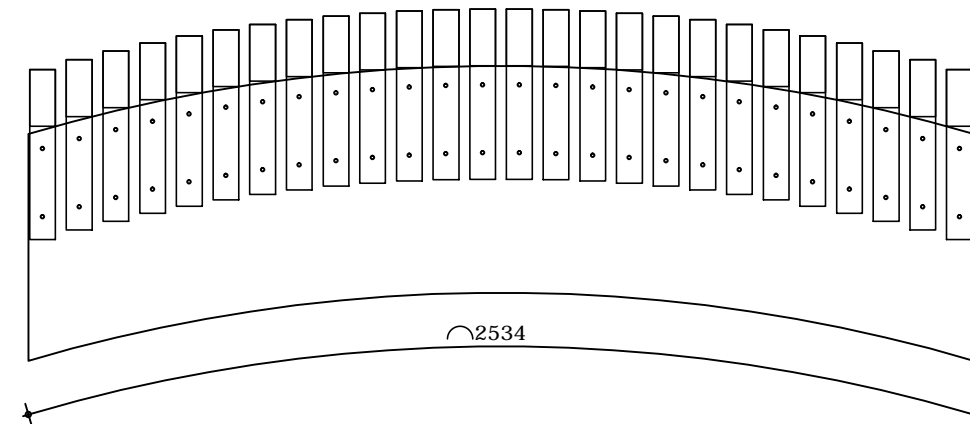

Bovenaanzicht

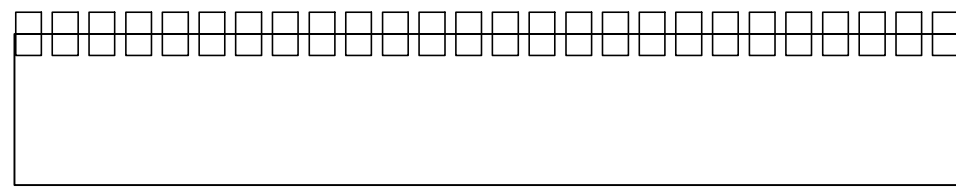

Vooraanzicht

26xA A=68mm
25xB B=29mm

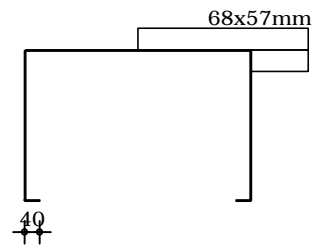
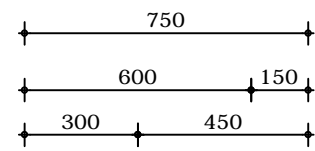
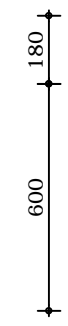

Verticale doorsnede

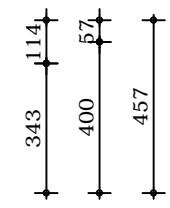

Gewicht : 186kg
Afwerking : RAL7021

<p>Omschrijving : Alva AVH1 Opdrachtgever : Adezz Werknummer : Standaard Plaats : Uden (NL) 1/1</p>	<p>Get. : R. Langens Schaal : 1:20 Datum : 01-04-2014 Wijz. :</p>
---	---